

ACCESS & SAFETY

HANDRAIL PRODUCTS 6

FLOOD PROTECTION 34

STAINLESS PRODUCTS 36

WALKWAY PRODUCTS 54

MESH, EXPANDED, PERFORATED 76

FENCING 86

GRP PRODUCTS 98

CLADDING 113

WROUGHT IRON + GATE SYSTEMS 118

ERW PRODUCTS 146

ANCILLARY PRODUCTS 148

**100's
OF NEW
PRODUCTS**

CALL YOUR NEAREST DEPOT FOR A FAST, COMPETITIVE QUOTE

ABERDEEN

Cloverfield Rd, Bridge of Don
ABERDEEN AB23 8FE
T: 01224 702 771
aberdeen@bmsteel.co.uk

AVON

Unit 18 Midsomer Enterprise Park,
Radstock Road,
Midsomer Norton
AVON BA3 2BB
T: 01761 416721
avon@bmsteel.co.uk

BANGOR

Unit 18, Llandygai Ind. Est.
BANGOR LL57 4YH
T: 01248 364 041
bangor@bmsteel.co.uk

CHEADLE

Duke Avenue,
Stanley Green Ind. Est.
CHEADLE HULME SK8 6QZ
T: 0161 485 8535
cheadle@bmsteel.co.uk

GLASGOW

Shieldhall Works, Hardgate Rd,
GLASGOW G51 4TB
T: 0141 445 2591
glasgow@bmsteel.co.uk

LIVERPOOL

Byng St/Seymour St,
Millers Bridge Ind. Est.
BOOTLE L20 1EE
T: 0151 922 4265
liverpool@bmsteel.co.uk

MORECAMBE

Unit 2, Middlegate,
White Lund Ind.
MORECAMBE LA3 3BN
T: 01524 67241
morecambe@bmsteel.co.uk

NOTTINGHAM

Basford Works, Arnold Rd,
NOTTINGHAM NG6 0EF
T: 0115 970 1171
nottingham@bmsteel.co.uk

PETERBOROUGH

Oxney Road,
Eastern Industry,
PETERBOROUGH PE1 5YW
T: 01733 312 921
peterborough@bmsteel.co.uk

PRESTON

Unit 1, Sellers St,
PRESTON PR1 5EU
T: 01772 459 111
preston@bmsteel.co.uk

BARCLAY & MATHIESON

293 Coleford Rd, Darnall
SHEFFIELD S9 5NF
T: 0114 254 3220
sales@barclayandmathieson.com

BM ARCHITECTURAL

293 Coleford Rd, Darnall
SHEFFIELD S9 5NF
T: 0114 254 3226
sales@bmarchitectural.com

IMS SITTINGBOURNE

1-5 Millen Rd, Sittingbourne,
KENT ME10 2BQ
T: 01795 293 104
sales@industrialmetal.co.uk

IMS SHOEBURYNES

Metalstock House,
Vanguard Way
ESSEX SS3 9RE
T: 01702 296 955
sales@industrialmetal.co.uk

PULMAN STEEL

Walton Street, Sowerby Bridge
WEST YORKSHIRE HX6 1AN
T: 01422 833 993
sales@pulmans.co.uk

SPS STEEL PLATE & SECTIONS

Shieldhall Works, Hardgate Rd,
GLASGOW G51 4TB
T: 0141 440 5860
sales@sps-bmsteel.co.uk

ANGUS F GUNN

Dalmacoulter Road,
Stirling Road Industrial Estate,
AIRDRIE ML6 7UD
T: 01236 766 102
sales@angusgunn.co.uk



-
-  **BM Steel**
 -  **Pulmans**
 -  **IMS**
 -  **SPS**
 -  **AFG**
 -  **BM Architectural
Barclay & Mathieson**
 -  **Service Centre**

DURBAR STAIR TREADS

**OFF-THE-SHELF SIMPLICITY
OR MANUFACTURED TO YOUR
SPECIFICATION**

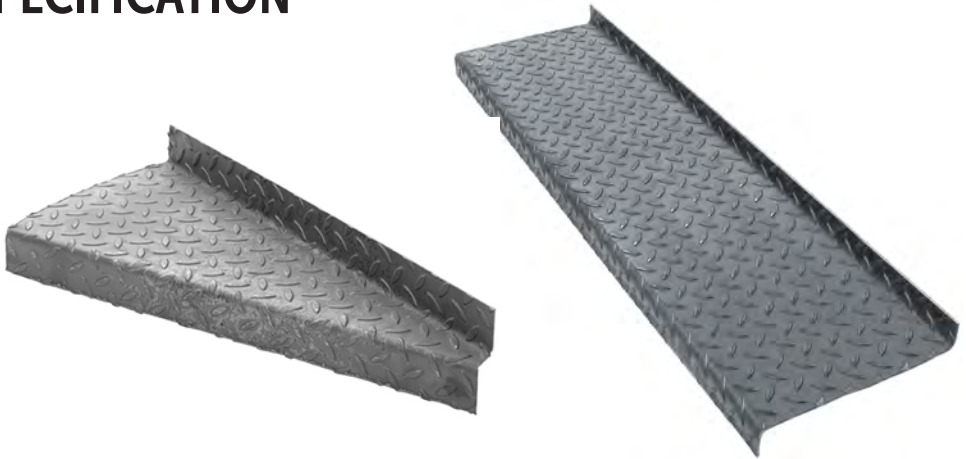

As well as offering standard, off-the-shelf Durbar Stair Tread from our Access & Safety product range, using our state-of-the-art facility we can also supply special sizes and spiral stair treads manufactured to your specification.

More details on our standard steel flooring ranges can be found in our Access & Safety Catalogue.

Please contact us for further details and specifications in the depot office.



**MAKE
ORDERING
FASTER
WITH A
TRADE
ACCOUNT.**

HANDRAIL PRODUCTS

HUGE TRADE DISCOUNT

SECTION GUIDE

HANDRAIL TUBES AND BENDS.....	7
HANDRAIL COMPONENTS & BARS	8
HANDRAIL CLAMPS	9
GRP HANDRAIL	13
DDA ASSIST RANGE.....	14
HANDRAIL STANDARDS.....	18
& CONNECTORS	
LADDERS.....	22
SAFETY GATES	30
GUARDRAIL ROOFING.....	31

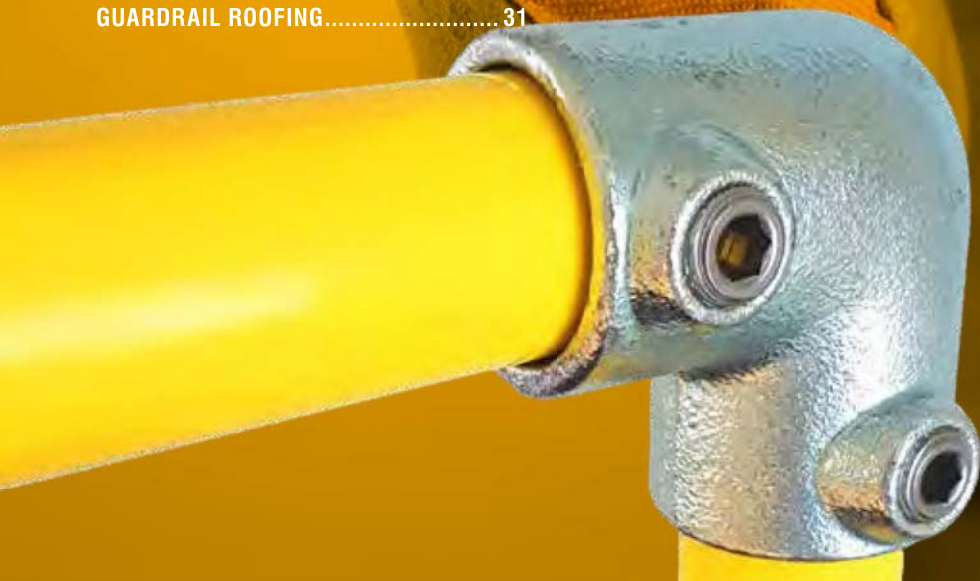

TUBES BS 1387 TUBE

- Finish: Self-colour, Galvanised, Prime painted and Varnished
- Tube thickness: Light, Medium, Heavy
- Tube ends: Plain or Screwed
- Ex-Stock: Medium plain end

 WIDE SIZE RANGE

 EX STOCK

 CHOICES OF FINISH

Metric NB (mm)	Imperial NB (inch)	Metric OD x T LIGHT	Metric OD x T MEDIUM	Metric OD x T HEAVY	To Suit Inter-clamp Size
20NB	3/4" NB	26.9mm x 2.3mm	27.2mm x 2.6mm	27.2mm x 3.2mm	A27
25NB	1" NB	33.7mm x 2.6mm	34.2mm x 3.2mm	34.2mm x 4.0mm	B34
32NB	1 1/4" NB	42.4mm x 2.6mm	42.9mm x 3.2mm	42.9mm x 4.0mm	C42
40NB	1 1/2" NB	48.3mm x 2.9mm	48.8mm x 3.2mm	48.8mm x 4.0mm	D48
50NB	2" NB	60.3mm x 2.9mm	60.8mm x 3.6mm	60.8mm x 4.5mm	E60
65NB	2 1/2" NB	76.1mm x 3.2mm	76.6mm x 3.6mm	76.6mm x 4.5mm	
80NB	3" NB	88.9mm x 3.2mm	89.5mm x 4.0mm	89.5mm x 5.0mm	
100NB	4" NB	114.9mm x 3.6mm	114.9mm x 4.5mm	114.9mm x 5.4mm	
125NB	5" NB		140.6mm x 5.0mm	140.6mm x 5.4mm	
150NB	6" NB		166.1mm x 5.0mm	166.1mm x 5.4mm	



HANDRAIL BENDS FOR USE WITH BS 1387 TUBE

- Finish: Self-colour or Galvanised
- Tube OD: 33.7, 42.4 or 48.3mm

Bend Type	25 NB	32 NB	40 NB
Return 350mm long x 550mm centre	1111.SC 1111.GA	1121.SC 1121.GA	1131.SC 1131.GA
Stair Return Bend 350mm long x 450mm centre, 38° standard	1112.SC 1112.GA	1122.SC 1122.GA	1132.SC 1132.GA
Ramp Bend 500mm x 500mm, 38° standard	1113.SC 1113.GA	1123.SC 1123.GA	1133.SC 1133.GA
90° Bend 500mm x 500mm	1114.SC 1114.GA	1124.SC 1124.GA	1134.SC 1134.GA

Return

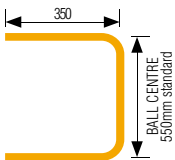

Stair Return Bend

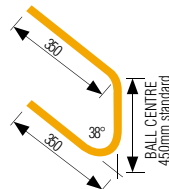

Ramp Bend

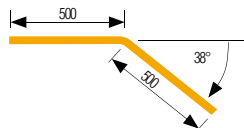

90° Bend

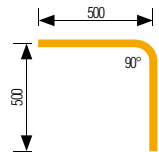

WELDABLE HANDRAILS FOR USE WITH BS 1387 TUBE

- Size: 76mm \varnothing x 4mm thick plate
- Upstand: 50mm from centre of backplate
- Countersunk holes to suit 6mm \varnothing screws

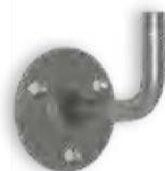

Cover for
Weldable Handrail Ref. 123.SC



**FOR A FAST,
COMPETITIVE QUOTE
CALL NOW!**

Diameter (mm)	Projection (mm)	Ref.
76	75	121.SC
76	100	122.SC

HANDRAIL BARS FOR USE WITH BS 1387 TUBE

- Mild Steel (S275JR) - 6m lengths



W (mm)	D (mm)
38	10
50	13

WELDABLE ELBOWS FOR USE WITH BS 1387 TUBE

- Finish: Self-colour



Metric NB (mm)	Metric OD (mm)	Radius (mm)	Ref:
25 NB	33.7mm	38.0mm	141.SC
32 NB	42.4mm	47.5mm	142.SC
40 NB	48.3mm	57.0mm	143.SC
50 NB	60.3mm	76.0mm	144.SC
65 NB	76.1mm	95.0mm	145.SC
80 NB	88.9mm	114.0mm	146.SC
100 NB	114.3mm	152.0mm	147.SC
125 NB	139.7mm	190.0mm	148.SC
150 NB	165.1mm	229.0mm	149.SC

WELDABLE BALLS FOR USE WITH BS 1387 TUBE

- Finish: Self-colour



Tube Size (mm)	Ball Dia (mm)	Ref.
25 NB	63mm	151.SC
25 NB	75mm	152.SC
32 NB	75mm	153.SC
40 NB	75mm	154.SC
40 NB	90mm	155.SC

HANDRAIL EASYCLAMP

To differentiate the Eazyclamp range from other systems and methods of construction, various advanced features have been incorporated into the design, production and finish of the fittings, with the clear aim of optimising the high quality and long life of the product. You can therefore be confident in your choice of brand.

TOP QUALITY GALVANISED FINISH

Eazyclamp components are hot dip galvanised to

BS EN ISO 1461:2009

Each product goes through stringent quality control to ensure a consistent and reliable product.

EASY RECOGNITION

Each fitting is clearly marked with the type and size for easy identification.

DOUBLE COATING

Fittings feature a secondary coating over the hot dipped galvanising to enhance corrosion protection and to extend the life of the product.

STAINLESS STEEL SCREWS

To increase corrosion resistance and durability, components are fitted with stainless steel screws.



MORE THAN STEEL

STANDARD RANGE







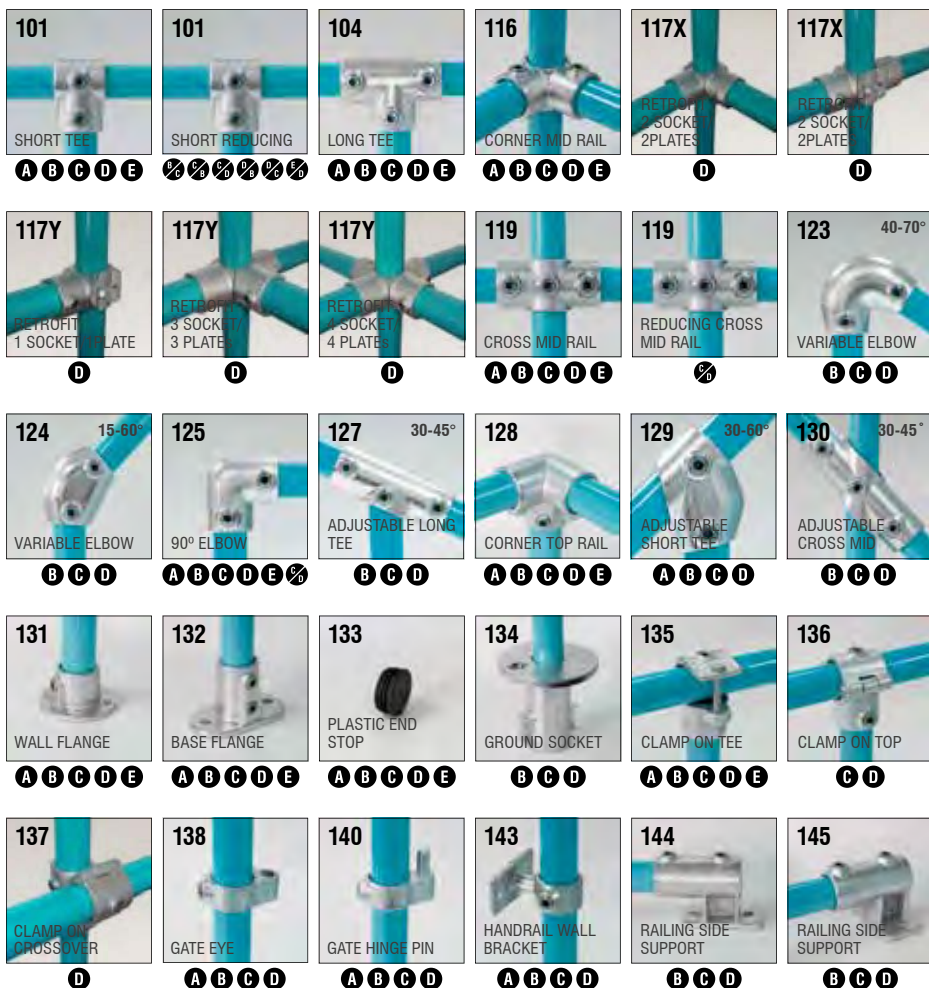





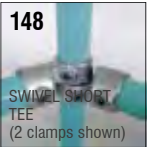





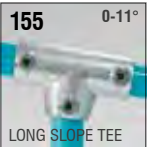









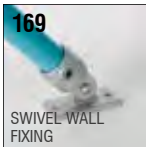
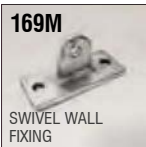



- Quick to assemble with a simple hexagon key
- For applications up to 1.5Kn/m
- Consistent product casting quality
- Galvanised malleable iron pipe fittings
- Tested for vibration endurance
- Manufactured to BS EN 1562:1997
- Finish: Double - Coated Hot dipped galvanisation to BS EN ISO 1461:1999
- 316 Stainless steel set screws (option for security pins)
- TUV-Rheinland Safety Approved

NOMINAL OUTSIDE
BORE DIA. (mm)

A	3/4"	26.9
B	1"	33.7
C	1 1/4"	42.4
D	1 1/2"	48.3
E	2"	60.3

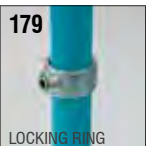

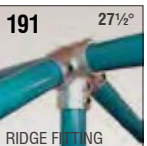
STANDARD RANGE Cont.

<p>146</p>  <p>TRIANGULAR SIDE PALM</p> <p>B C D</p>	<p>147</p>  <p>INTERNAL SWIVEL TEE</p> <p>B C D</p>	<p>148</p>  <p>SWIVEL SHORT TEE (2 clamps shown)</p> <p>A B C D E</p>	<p>149</p>  <p>EXTERNAL SLEEVE JOINT</p> <p>A B C D E</p>	<p>150</p>  <p>INTERNAL SLEEVE JOINT</p> <p>B C D</p>	<p>152 0-11°</p>  <p>SLOPE BASE FLANGE</p> <p>B C D</p>
<p>153 0-11°</p>  <p>SHORT SLOPE TEE</p> <p>B C D</p>	<p>154 0-11°</p>  <p>SHORT ELBOW</p> <p>B C D</p>	<p>155 0-11°</p>  <p>LONG SLOPE TEE</p> <p>B C D</p>	<p>156 0-11°</p>  <p>SLOPE MID CROSS</p> <p>B C D</p>	<p>158</p>  <p>CENTRE CROSS</p> <p>A B C D E</p>	<p>160</p>  <p>CLAMP ON CROSSOVER</p> <p>A B C D E</p>
<p>161</p>  <p>CROSSOVER</p> <p>A B C D E</p>	<p>161</p>  <p>CROSSOVER</p> <p>A B C D E</p>	<p>165</p>  <p>COMBINED TEE AND CROSSOVER</p> <p>B C D E</p>	<p>166 0-120°</p>  <p>ADJUSTABLE KNUCKLE</p> <p>B C D E</p>	<p>167</p>  <p>DOUBLE SWIVEL CONNECTOR</p> <p>A B C D E</p>	<p>168</p>  <p>CORNER DOUBLE SWIVEL CONNECTOR</p> <p>A B C D E</p>
<p>169</p>  <p>SWIVEL WALL FIXING</p> <p>A B C D E</p>	<p>169M</p>  <p>SWIVEL WALL FIXING</p> <p>A B C D E</p>	<p>170</p>  <p>SINGLE MESH PANEL CLIP</p> <p>A B C D E</p>	<p>171</p>  <p>DOUBLE MESH PANEL CLIP</p> <p>A B C D E</p>	<p>172M</p>  <p>OFFSET SWIVEL MALE</p> <p>C D</p>	<p>173</p>  <p>SINGLE SWIVEL COMBINATION</p> <p>A B C D E</p>
<p>173F</p>  <p>SINGLE SWIVEL FEMALE</p> <p>A B C D E</p>	<p>173M</p>  <p>SINGLE SWIVEL MALE</p> <p>A B C D E</p>	<p>174</p>  <p>SWIVEL TEE</p> <p>D</p>	<p>174M</p>  <p>SWIVEL TEE MALE</p> <p>D</p>	<p>175M</p>  <p>SWIVEL ELBOW MALE</p> <p>D</p>	<p>176</p>  <p>SIDE OUTLET TEE</p> <p>A B C D E</p>
<p>179</p>  <p>LOCKING RING</p> <p>A B C D E</p>	<p>182</p>  <p>HOOK</p> <p>A B C D</p>	<p>185 27½°</p>  <p>EAVES FITTING</p> <p>D</p>	<p>191 27½°</p>  <p>RIDGE FITTING</p> <p>D</p>	<p>192</p>  <p>SIGN CLAMP</p> <p>B C D</p>	<p>197</p>  <p>SIGN CLAMP</p> <p>D</p>

MORE THAN STEEL

STANDARD RANGE Cont.



B C D



B C D



D



C D



D

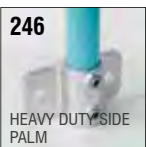

B C D



B C D



D



D



D



D



A B C D E



GRP HANDRAIL

**HUGE
TRADE
DISCOUNT**



Ref:	Description
42101	Round Tube 50mm OD x 40mm ID



Ref:	Description
42102	W Toe plate (kick plate)



Ref:	Description
42103	3 way connection Tee connection



Ref:	Description
42105	90 Deg Elbow



Ref:	Description
42107	Universal Joint



Ref:	Description
42109	Stanchion Post Base Foot



Ref:	Description
42107	Side Fit



Ref:	Description
42111	Triangle Base Foot



Ref:	Description
42113	3 Way Corner



Ref:	Description
42114	4 Way Corner

MORE THAN STEEL

400 SERIES - PREMADE POST

A rapid assembly and cost effective solution for industrial and workplace safety barriers. Ideal for machinery guardrails, zone segregation and personnel safety.

- Smooth, in-line handrail range.
- Compatible for use in conjunction with the standard Interclamp range.
- Helps to meet compliance with the Equality Act 2010 (formerly DDA) and Building Regulations Part M 2013.

- Saddle-type assembly or internally expanding to suit 3.25mm wall tube.
- Optional O-rings for ease of installation and aesthetically pleasing finish.
- Easy accommodation of slopes and access ramps.



401 Return Termination	
Part	Code
Galvanised	
C42	C42/401-G
D48	D48/401-G
Painted RAL 1018	
C42	C42/401-1018
D48	D48/401-1018

402 End Post	
Part	Code
Galvanised	
C42	C42/402-G
D48	D48/402-G
Painted RAL 1018	
C42	C42/402-1018
D48	D48/402-1018

403 Mid Post	
Part	Code
Galvanised	
C42	C42/403-G
D48	D48/403-G
Painted RAL 1018	
C42	C42/403-1018
D48	D48/403-1018

404 Corner Post	
Part	Code
Galvanised	
C42	C42/404-G
D48	D48/404-G
Painted RAL 1018	
C42	C42/404-1018
D48	D48/404-1018

405 End Post 0-11°	
Part	Code
Galvanised	
C42	C42/405-G
D48	D48/405-G
Painted RAL 1018	
C42	C42/405-1018
D48	D48/405-1018



406 Mid Post 0-11°	
Part	Code
Galvanised	
C42	C42/401-G
D48	D48/401-G
Painted RAL 1018	
C42	C42/401-1018
D48	D48/401-1018

SIZING INFORMATION

Size	Post	Mid Rail	Top Rail
C42	C42	C42	C42
D48	D48	D48	D48

ACCESSORIES

<p>150 B34 C42 D48</p>		<p>764 C42</p>	
<p>797 C42</p>		<p>3m C42 D48</p>	



DDA ASSIST RANGE

- Helps to meet compliance with UK-DDA & Building Regulations Part M
- Flush joints with size C42 tube only
- Tubes and fittings may be coated to RAL colours to help meet "not cold to the touch" and contrasting colour requirements
- Suitable for upgraded retrofit

- ✔ QUICK ASSEMBLY
- ✔ DDA COMPLIANT
- ✔ SAFETY APPROVED



TYPICAL ASSEMBLIES



Some configurations are shown with optional O-rings and some require multiple fittings.







MORE THAN STEEL



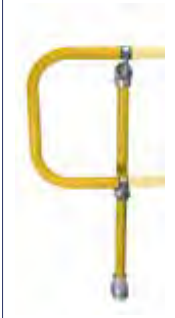

800 SERIES - DDA ASSIST POSTS

OFFSET TOP & OFFSET MIDDLE RAILS

Level Sites

801		805		806		807		808	
Return Termination		External 90° Corner		Internal 90° Corner		Expanding Mid Post		Saddle Mid Post	
									
Part	Code	Part	Code	Part	Code	Part	Code	Part	Code
Galvanised		Galvanised		Galvanised		Galvanised		Galvanised	
C42	C42/801-G	C42	C42/805-G	C42	C42/806-G	C42	C42/807-G	C42	C42/808-G
D48	D48/801-G	D48	D48/805-G	D48	D48/806-G	D48	D48/807-G	D48	D48/808-G
Painted RAL 1018		Painted RAL 1018		Painted RAL 1018		Painted RAL 1018		Painted RAL 1018	
C42	C42/801-1018	C42	C42/805-1018	C42	C42/806-1018	C42	C42/807-1018	C42	C42/808-1018
D48	D48/801-1018	D48	D48/805-1018	D48	D48/806-1018	D48	D48/807-1018	D48	D48/808-1018

Sloping Sites (0+11°)

821		827		828	
Ramp Termination		Expanding Mid Post		Saddle Mid post	
					
Part	Code	Part	Code	Part	Code
Galvanised		Galvanised		Galvanised	
C42	C42/821-G	C42	C42/827-G	C42	C42/828-G
D48	D48/821-G	D48	D48/827-G	D48	D48/828-G
Painted RAL 1018		Painted RAL 1018		Painted RAL 1018	
C42	C42/821-1018	C42	C42/827-1018	C42	C42/828-1018
D48	D48/821-1018	D48	D48/827-1018	D48	D48/828-1018

SIZING INFORMATION

Size	Post	Mid Rail	Top Rail
C42	C42	C42	C42
D48	D48	D42	D42

OFFSET TOP & INLINE MIDDLE RAILS

Level Sites

874		875		876		877		878	
End Termination		External 90° Corner		Internal 90° Corner		Expanding Mid Post		Saddle Mid Post	
Part	Code	Part	Code	Part	Code	Part	Code	Part	Code
Galvanised		Galvanised		Galvanised		Galvanised		Galvanised	
C42	C42/874-G	C42	C42/875-G	C42	C42/876-G	C42	C42/877-G	C42	C42/878-G
D48	D48/874-G	D48	D48/875-G	D48	D48/876-G	D48	D48/877-G	D48	D48/878-G
Painted RAL 1018		Painted RAL 1018		Painted RAL 1018		Painted RAL 1018		Painted RAL 1018	
C42	C42/874-1018	C42	C42/875-1018	C42	C42/876-1018	C42	C42/877-1018	C42	C42/878-1018
D48	D48/874-1018	D48	D48/875-1018	D48	D48/876-1018	D48	D48/877-1018	D48	D48/878-1018

Sloping Sites (0+11°)

884		887		888	
Ramp Termination		Expanding Mid Post		Saddle Mid post	
Part	Code	Part	Code	Part	Code
Galvanised		Galvanised		Galvanised	
C42	C42/884-G	C42	C42/887-G	C42	C42/888-G
D48	D48/884-G	D48	D48/887-G	D48	D48/888-G
Painted RAL 1018		Painted RAL 1018		Painted RAL 1018	
C42	C42/884-1018	C42	C42/887-1018	C42	C42/888-1018
D48	D48/884-1018	D48	D48/887-1018	D48	D48/888-1018

SIZING INFORMATION

Size	Post	Mid Rail	Top Rail
C42	C42	C42	C42
D48	D48	D48	C42

MORE THAN **STEEL**

HANDRAIL STANDARDS

HANDRAIL STANDARDS are the benchmark for industry. Available with a wide range of fixings and shank diameters. You can be confident our handrail will meet your needs and UK standards.

**FOR A FAST,
COMPETITIVE QUOTE
CALL NOW!**

COMPREHENSIVE RANGE

Shank availability: 33.7mm (25); 42.4 (32) or 48.3mm (40) ensures suitable sizing for whatever requirement.



QUALITY FINISH

Supplied as either self colour (SC) or Galvanised (GA) finish.

BESPOKE SIZING

Simply state the required measurement when ordering.

VERSATILE FITTINGS

Available with a number of base fixings (see overleaf)

LOADING TABLE

		Maximum recommended spacings for 1100mm high posts		
Handrailing Diameter mm		33.7mm O.D.	42.4mm O.D.	48.3mm O.D.
Shank Diameter mm		33.7mm O.D.	42.4mm O.D.	48.3mm O.D.
Maximum Recommended Spacing 2000mm	0.36 KN/M	1040	1720	2000
	0.74 KN/M	520	860	1280

Fixing holes to be 18mm diameter U.N.O.

BASE TYPES

HORIZONTAL SIDE PALM (HSP)

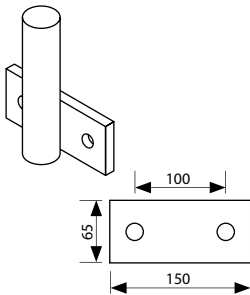

VERTICAL SIDE PALM (VSP)

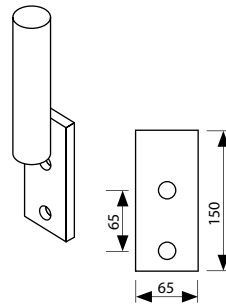

TRIANGULAR SIDE PALM (VSP)

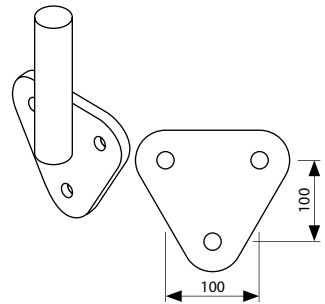

CIRCULAR BASE (CB)

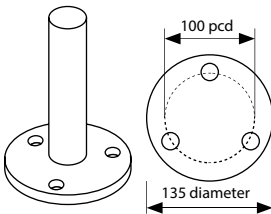

FLAT BASE (FB)

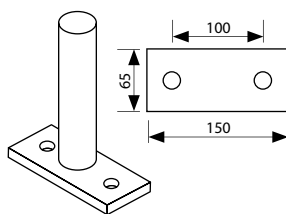

RAKED (RB)

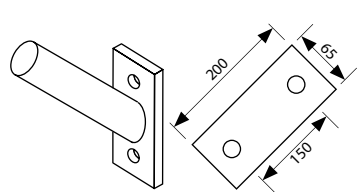

CONNECTORS

Crimps



Straight Connector 25mm NB
Product Ref: KCB4



Right Angle bend 25mm NB
Product Ref: KCB5



Kick Clamps
Product Ref:
K25 (25NB)
K40 (32 to 40NB)

Toe Plate Connectors



Internal Corner
Product Ref:
KCB1



External Corner
Product Ref:
KCB2



Straight Connector
Product Ref:
KCB3

MORE THAN STEEL

HANDRAILS STANDARDS

Please refer to page 16 for dimensional information

A - Shank Dia.

B - Ball Dia.

C - Handrail Dia.

Part T1			
Size NB			Ref
A	B	C	
Self Coloured			
25	63	25	1611.SC
32	63	25	1612.SC
32	75	32	1613.SC
40	75	25	1615.SC
40	75	32	1616.SC
40	90	40	1614.SC
Galvanised			
25	63	25	1611.GA
32	63	25	1612.GA
32	75	32	1613.GA
40	75	25	16.15.GA
40	75	32	1616.GA
40	90	40	1614.GA

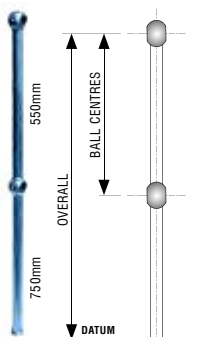

- Finish: Self-colour (SC) or Galvanised (GA)
- Shank OD: 33.7(25), 42.4 (32) or 48.3mm (40)
- Base thickness: 12mm (standard) or 15mm (bespoke)
- Base or Palm (Please refer to Handrail Standard Order Form)

Part T1FB			
Size NB			Ref
A	B	C	
Self Coloured			
25	63	25	1621.SC
32	63	25	1622.SC
32	75	32	1623.SC
40	75	25	1625.SC
40	75	32	1626.SC
40	90	40	1624.SC
Galvanised			
25	63	25	1621.GA
32	63	25	1622.GA
32	75	32	1623.GA
40	75	25	1625.GA
40	75	32	1626.GA
40	90	40	1624.GA

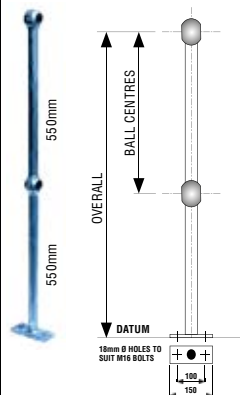

Part T1HSP			
Size NB			Ref
A	B	C	
Self Coloured			
25	63	25	1631.SC
32	63	25	1632.SC
32	75	32	1633.SC
40	75	25	1635.SC
40	75	32	1636.SC
40	90	40	1634.SC
Galvanised			
25	63	25	1631.GA
32	63	25	1632.GA
32	75	32	1633.GA
40	75	25	1635.GA
40	75	32	1636.GA
40	90	40	1634.GA

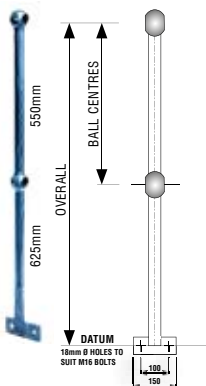

Part T1VSP			
Size NB			Ref
A	B	C	
Self Coloured			
25	63	25	1641.SC
32	63	25	1642.SC
32	75	32	1643.SC
40	75	25	1645.SC
40	75	32	1646.SC
40	90	40	1644.SC
Galvanised			
25	63	25	1641.GA
32	63	25	1642.GA
32	75	32	1643.GA
40	75	25	1645.GA
40	75	32	1646.GA
40	90	40	1644.GA

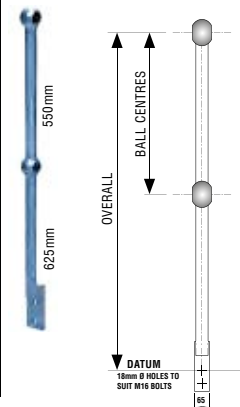

Part T2R			
Size NB			Ref
A	B	C	
Self Coloured			
25	63	25	1671.SC
32	63	25	1672.SC
32	75	32	1673.SC
40	75	25	1675.SC
40	75	32	1676.SC
40	90	40	1674.SC
Galvanised			
25	63	25	1671.GA
32	63	25	1672.GA
32	75	32	1673.GA
40	75	25	1675.GA
40	75	32	1676.GA
40	90	40	1674.GA

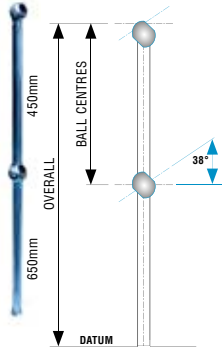

Part T2R8			
Size NB			Ref
A	B	C	
Self Coloured			
25	63	25	1651.SC
32	63	25	1652.SC
32	75	32	1653.SC
40	75	25	1655.SC
40	75	32	1656.SC
40	90	40	1654.SC
Galvanised			
25	63	25	1651.GA
32	63	25	1652.GA
32	75	32	1653.GA
40	75	25	1655.GA
40	75	32	1656.GA
40	90	40	1654.GA

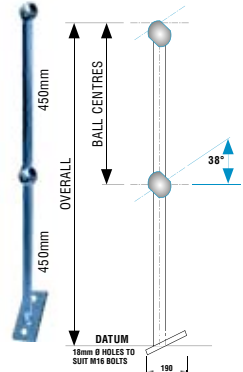

Part T2HSP*			
Size NB			Ref
A	B	C	
Self Coloured			
25	63	25	1661.SC.XH
32	63	25	1662.SC.XH
32	75	32	1663.SC.XH
40	75	25	1665.SC.XH
40	75	32	1666.SC.XH
40	90	40	1664.SC.XH
Galvanised			
25	63	25	1661.GA.XH
32	63	25	1662.GA.XH
32	75	32	1663.GA.XH
40	75	25	1665.GA.XH
40	75	32	1666.GA.XH
40	90	40	1664.GA.XH

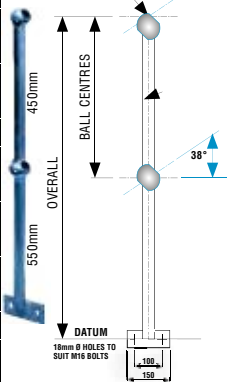

Dimensions shown are intended as a guide.
Other Dimensions can be supplied on short lead times.

FOR A FAST,
COMPETITIVE QUOTE
CALL NOW!

*Please specify left or right handed when ordering.

MORE THAN STEEL

FIXED ACCESS LADDERS CAGED OR UNCAGED

- Available as kit components or fully bolted construction to enable self-assembly on site.
- Available with hooped cage & step over to connect to a walking platform.
- Ladder length up to 6m
- Stays 1500mm centres (Max)
- Bolted splice to suit desired height
- Constructed from mild steel S275, generally to BS421
- Finish: Hot Dipped Galvanised, according to BSEN ISO 1461

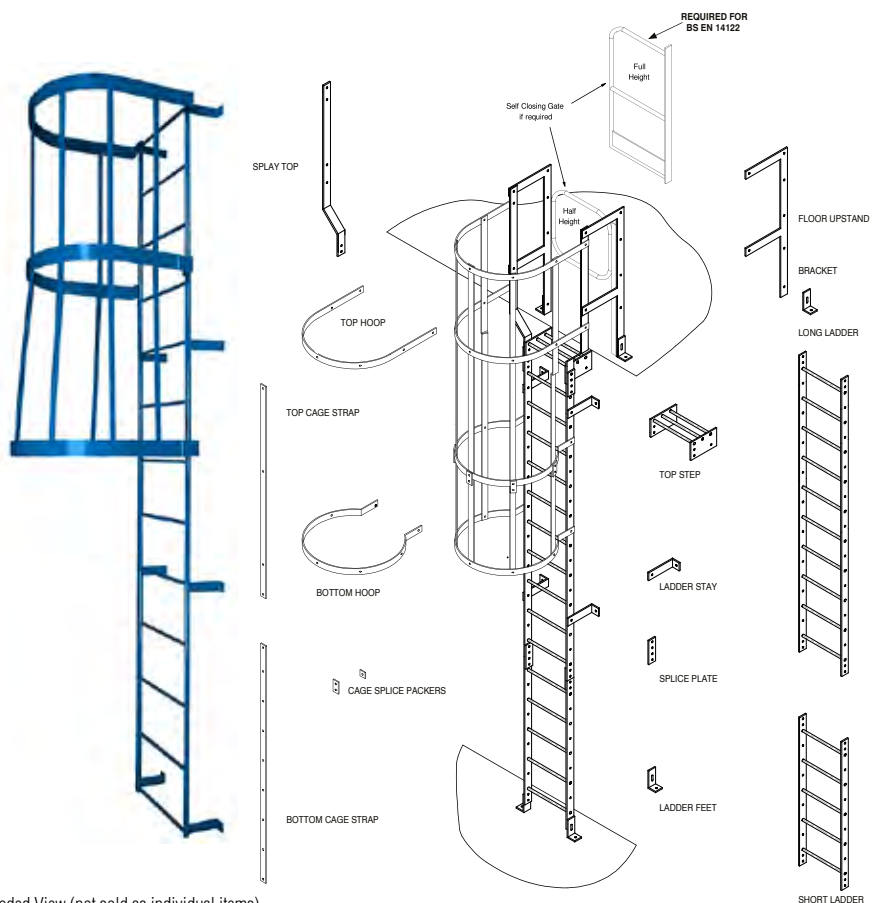

Exploded View (not sold as individual items).

Ladders are designed in accordance with BS5395 and are designed to suit specific applications.

Please contact our sales office ready with your fabrication drawing to obtain a quote or technical assistance.

FIXED ACCESS LADDERS LADDER KITS

AX1 - 2000-2300mm Rise Ladder

Ref	Description
AX2000	Type 1 - Rise ladder 2000 - 2300 mm

Component List
Long ladder section (2500 mm)
Top step (4 x M12 x 50 mm bolts inc.)
Ladder feet (pair 4 x M12x35 mm bolts inc.)
Ladder stays (pair - 4 x M12x35 mm bolts inc.)
Upper hoop Ø700 x 750mm (4 x M12x36 mm bolts inc.)
Lower hoop Ø700 x 750mm (4 x M12x36 mm bolts inc.)
Splice plates (pair - 6 x M12x35 mm bolts inc.)
Upper cage strap (set 5)
Lower cage strap (set 5 - cage splices and 10 x M12x50 mm bolts inc.)

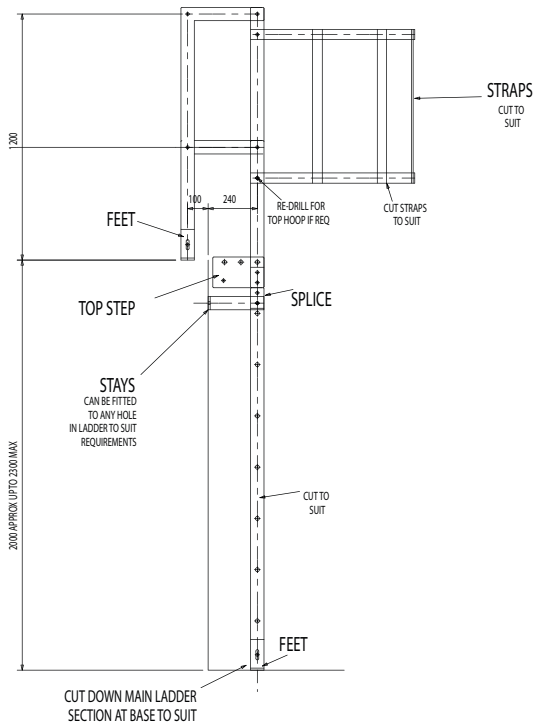

MORE THAN STEEL

AX2 - 2400-2700mm Rise Ladder

Ref	Description
AX2500	Type 2 - Rise ladder 2400 - 2700 mm

Component List
Long ladder section (2500 mm)
Ladder extension (pair - ladder feet, 4 x M12 x 35 mm bolts inc.)
Top step (4 x M12 x 50 mm bolts inc.)
Ladder feet (pair 4 x M12x35 mm bolts inc.)
Ladder stays (pair - 4 x M12x35 mm bolts inc.)
Upper hoop Ø700 x 750mm (4 x M12x36 mm bolts inc.)
Lower hoop Ø700 x 750mm (4 x M12x36 mm bolts inc.)
Splice plates (pair - 6 x M12x35 mm bolts inc.)
Upper cage strap (set 5)
Lower cage strap (set 5 - cage splices and 10 x M12x50 mm bolts inc.)

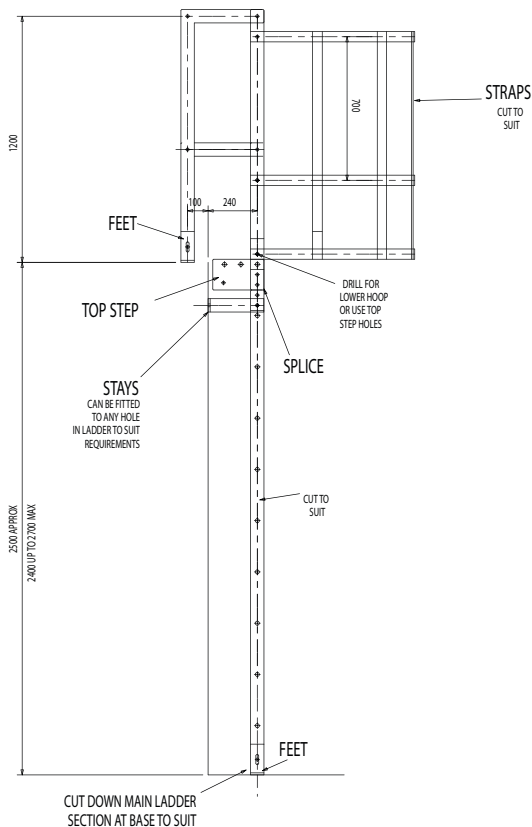

AX3 - 2800-3200mm Rise Ladder

Ref	Description
AX3000	Type 3 - Rise ladder 2800 - 3200 mm

Component List
Long ladder section (2500 mm)
Short ladder section (1250 mm)
Ladder extension (pair - ladder feet, 4 x M12 x 35 mm bolts inc.)
Top step (4 x M12 x 50 mm bolts inc.)
Ladder feet (pair 4 x M12x35 mm bolts inc.)
Ladder stays (pair - 4 x M12x35 mm bolts inc.)
Upper hoop Ø700 x 750mm (4 x M12x36 mm bolts inc.)
Lower hoop Ø700 x 750mm (4 x M12x36 mm bolts inc.)
Splice plates (pair - 6 x M12x35 mm bolts inc.)
Upper cage strap (set 5)
Lower cage strap (set 5 - cage splices and 10 x M12x50 mm bolts inc.)

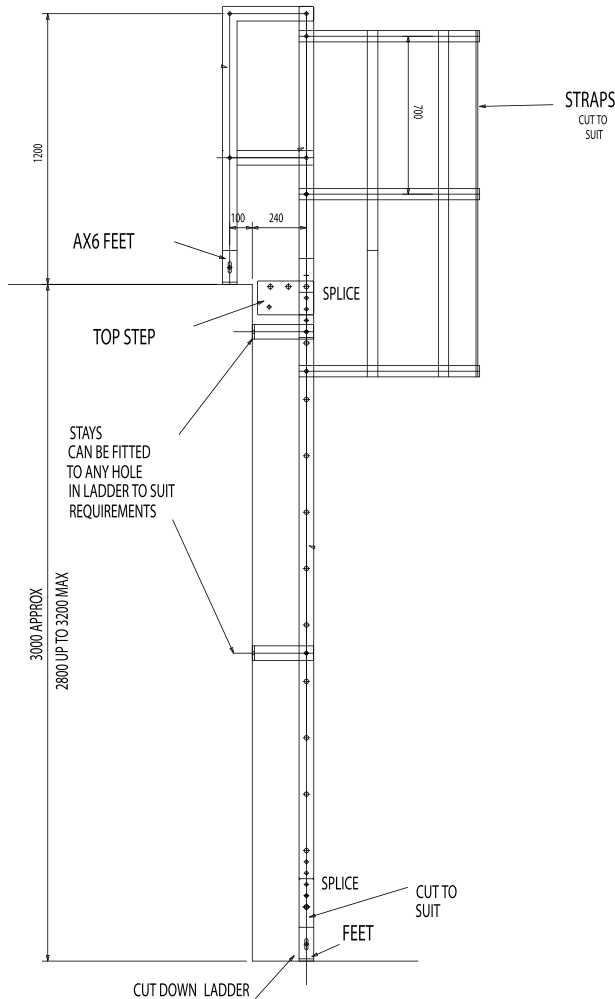

MORE THAN STEEL

FIXED ACCESS LADDERS LADDER KITS

AX4 - 3300-3800mm Rise Ladder

Ref	Description
AX3500	Type 3 - Rise ladder 3300 - 3800 mm

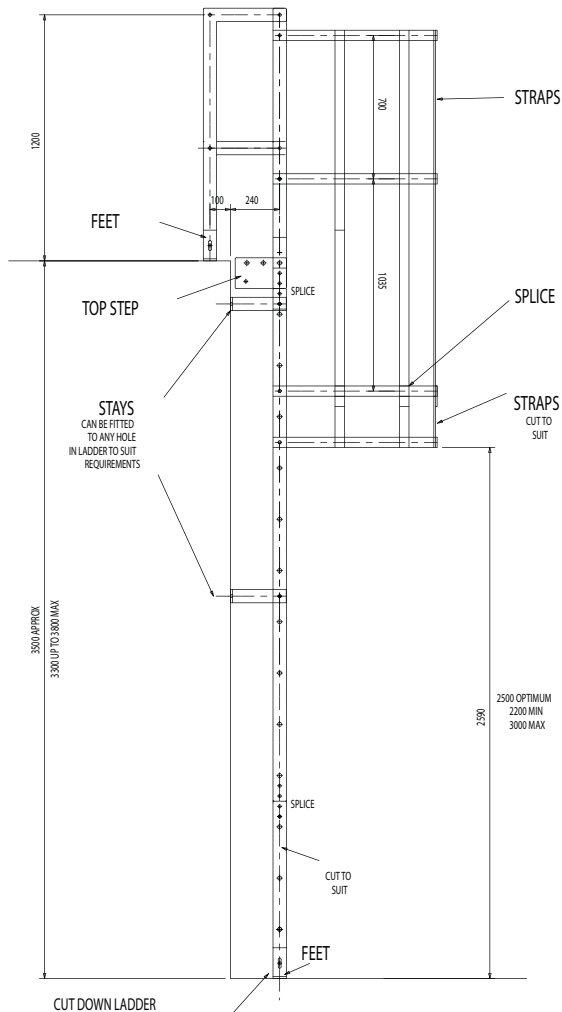

Component List
Long ladder section (2500 mm)
Short ladder section (1250 mm)
Ladder extension (pair - ladder feet, 4 x M12 x 35 mm bolts inc.)
Top step (4 x M12 x 50 mm bolts inc.)
Ladder feet (pair 4 x M12x35 mm bolts inc.)
Ladder stays (pair - 4 x M12x35 mm bolts inc.)
Upper hoop Ø700 x 750mm (4 x M12x36 mm bolts inc.)
Lower hoop Ø700 x 750mm (4 x M12x36 mm bolts inc.)
Splice plates (pair - 6 x M12x35 mm bolts inc.)
Upper cage strap (set 5)
Lower cage strap (set 5 - cage splices and 10 x M12x50 mm bolts inc.)

AX5 - 3900-4300mm Rise Ladder

Ref	Description
AX4000	Type 3 - Rise ladder 3900 - 4300 mm

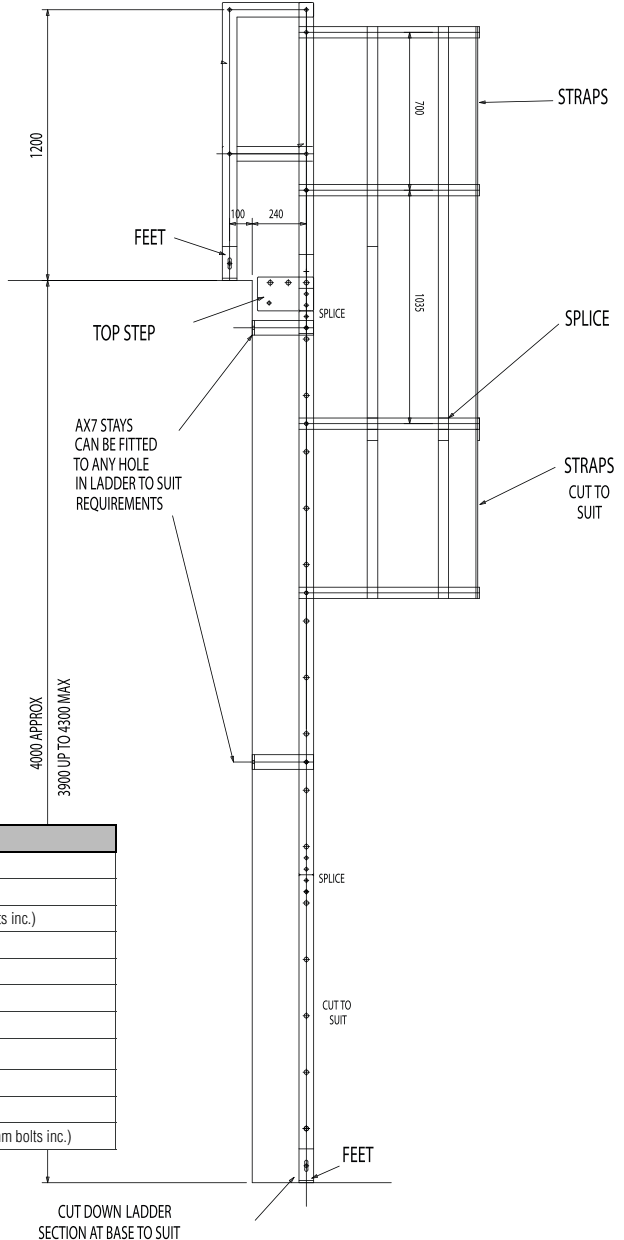

Component List
Long ladder section (2500 mm)
Short ladder section (1250 mm)
Ladder extension (pair - ladder feet, 4 x M12 x 35 mm bolts inc.)
Top step (4 x M12 x 50 mm bolts inc.)
Ladder feet (pair 4 x M12x35 mm bolts inc.)
Ladder stays (pair - 4 x M12x35 mm bolts inc.)
Upper hoop $\varnothing 700 \times 750$ mm (4 x M12x36 mm bolts inc.)
Lower hoop $\varnothing 700 \times 750$ mm (4 x M12x36 mm bolts inc.)
Splice plates (pair - 6 x M12x35 mm bolts inc.)
Upper cage strap (set 5)
Lower cage strap (set 5 - cage splices and 10 x M12x50 mm bolts inc.)

4000 APPROX
3900 UP TO 4300 MAX

CUT DOWN LADDER
SECTION AT BASE TO SUIT

MORE THAN STEEL

FIXED ACCESS LADDERS LADDER KITS

AX6 - 4400-5200mm Rise Ladder

Ref	Description
AX4500	Type 3 - Rise ladder 4400 - 5200 mm

Component List
Long ladder section (2500 mm)
Short ladder section (1250 mm)
Ladder extension (pair - ladder feet, 4 x M12 x 35 mm bolts inc.)
Top step (4 x M12 x 50 mm bolts inc.)
Ladder feet (pair 4 x M12x35 mm bolts inc.)
Ladder stays (pair - 4 x M12x35 mm bolts inc.)
Upper hoop $\varnothing 700 \times 750$ mm (4 x M12x36 mm bolts inc.)
Lower hoop $\varnothing 700 \times 750$ mm (4 x M12x36 mm bolts inc.)
Splice plates (pair - 6 x M12x35 mm bolts inc.)
Upper cage strap (set 5)
Lower cage strap (set 5 - cage splices and 10 x M12x50 mm bolts inc.)

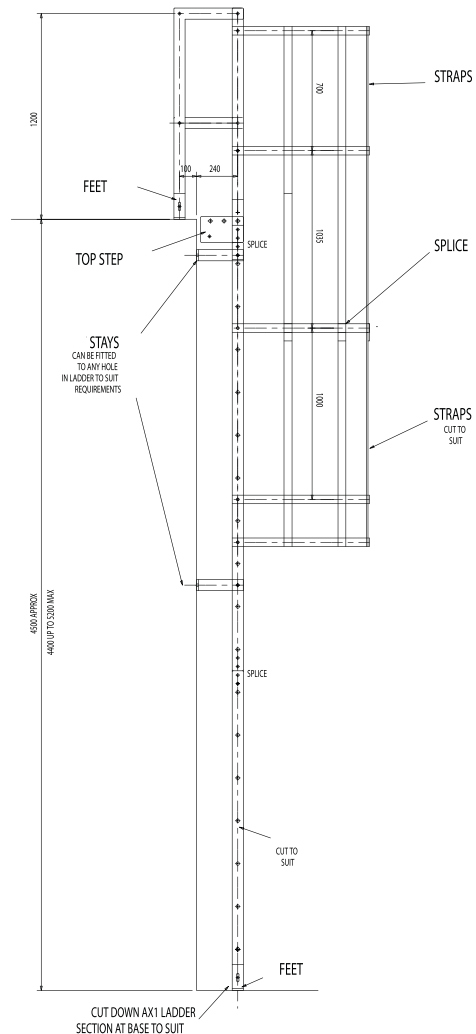

AX7 - 5300-6000mm Rise Ladder

Ref	Description
AX6000	Type 3 - Rise ladder 5300 - 6000 mm

Component List
Long ladder section (2500 mm)
Short ladder section (1250 mm)
Ladder extension (pair - ladder feet, 4 x M12 x 35 mm bolts inc.)
Top step (4 x M12 x 50 mm bolts inc.)
Ladder feet (pair 4 x M12x35 mm bolts inc.)
Ladder stays (pair - 4 x M12x35 mm bolts inc.)
Upper hoop Ø700 x 750mm (4 x M12x36 mm bolts inc.)
Lower hoop Ø700 x 750mm (4 x M12x36 mm bolts inc.)
Splice plates (pair - 6 x M12x35 mm bolts inc.)
Upper cage strap (set 5)
Lower cage strap (set 5 - cage splices and 10 x M12x50 mm bolts inc.)

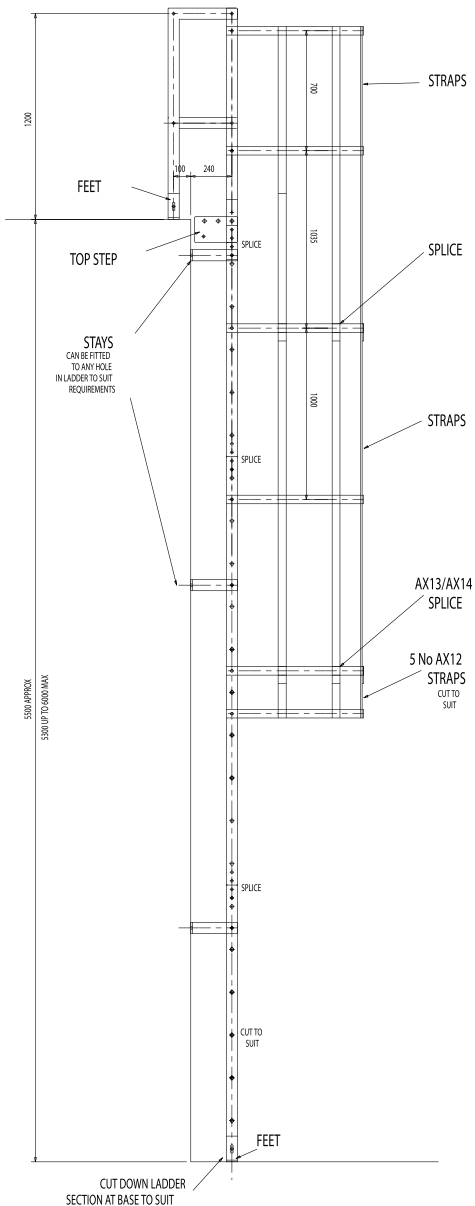

SAFETY GATES SELF CLOSING

- Self-closing gates (sprung top hinge)
- Tube OD: 33.7, 42.4 or 48.3mm
- Self Colour or Galvanised
- Half-height (ex-stock) or full height (on order)
- Ex-stock size: 778 (gap) x 550mm (centres)
- Left or right hand opening
- Supplied with flat plate
- Other sizes on request

Half Height Gate

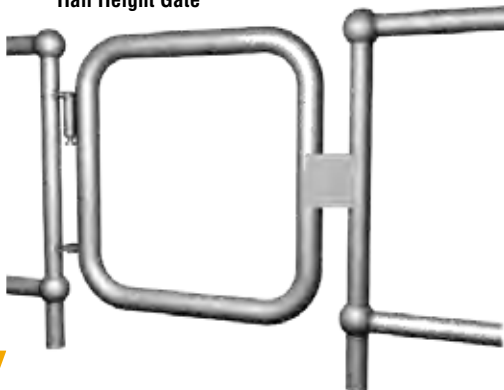

Ref	Metric NB (mm)	W (mm)	C (mm)
1901.GA.RH	25	778	550
1902.GA.RH	32	778	550
1903.GA.RH	40	778	550

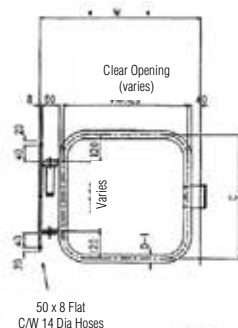
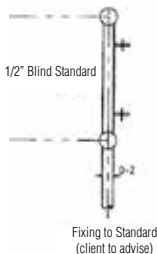

Please contact our sales office ready with your fabrication drawing to obtain a quote or technical assistance.

SELF CLOSING GATE HINGE

- Complete set, (screws, washers, split pin and assembly details)
- Galvanised spring barrel

Ref	Description
11001.KITRD	To suit Round tube
11002.KITRD	To suit Box section



EAZY ROOF

FREE STANDING ROOF EDGE PROTECTION

- Easy to erect and install: modular system based on pre-assembled uprights, 2.5m rails and slide-on weight.
- Safe: Fully tested to EN13374:2004, Class A
- Long-lasting: between 15 and 25 year lifespan (depending on location) based on galvanised tubes and A2 stainless steel fixing screws
- Non-Penetrative: Can be used on all roofing surface materials.
- Can be used as a temporary or permanent structure
- Cost Effective
- Versatile: available as Standard, Top Fix, Parapet-Fix or Collapsible.



EXPLODED VIEW OF EAZY ROOF

- ✓ QUICK ASSEMBLY
- ✓ VERSATILE DESIGN
- ✓ COST EFFECTIVE



EAZY ROOF AT WORK



EAZY ROOF AT WORK

MORE THAN STEEL

EAZY ROOF FREE STANDING ROOF EDGE PROTECTION



Standard

Component	Ref.
Main Support	11101
Intermediate Support	11102
2.5m Rail	11103
20kg Rubber Weight	11104
90° Bend	11105
180° End	11106



Parapet Fix

Component	Ref.
Top Fix Support Bracket	11107
2.5m Rail	11103
90° Bend	11105
180° End	11106



Top Fix

Component	Ref.
Top Fix Support Leg	11108
2.5m Rail	11103
90° Bend	11105
180° End	11106

Collapsible

Component	Ref.
Folding Upright	11109
2.5m Rail	11103
Rubber Weight	11104
180° End	11106
90° Elbow	125-D48
Short Tee	101-D48



Accessories

Component	Ref.
Top Riser Unit	11110
Half Height Spring Loaded Access Gate	11111
Variable Elbow	166-D48

Top Riser

PROTECTION FOR HIGH FLOOD RISK AREAS.

NEW! PRODUCT LINE.

More and more often, we are seeing how inadequately many buildings are protected from the consequences of flooding. Flood water and mud slides penetrating into property put lives and possessions at risk. And they always wreak a high financial cost in terms of damage. Our patented galvanised steel flood protection system now gives you the ability to create effective bulkheads to seal off openings in endangered buildings.

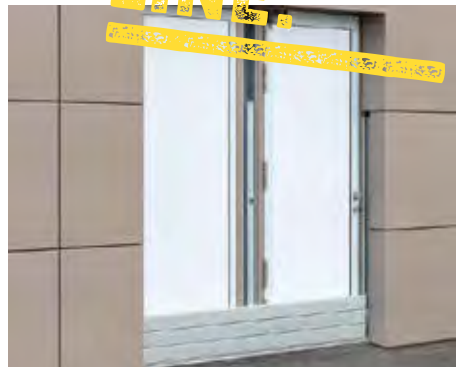

Modular design, the system is universally applicable and can be used in variety of different situations.

The patented securing system enables components to be installed quickly whenever catastrophe looms, adapting to different wall thicknesses and surrounding masonry to provide a firm seal for openings. The highly resistant steel wall that it forms provides active security and a high level of protection in flood-threatened areas.

FLOOD BARRIER

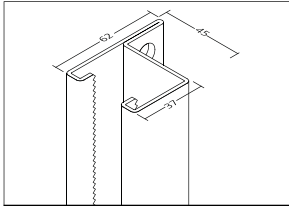

Ref:	Description
901200	Toothed track, outside. 4500mm

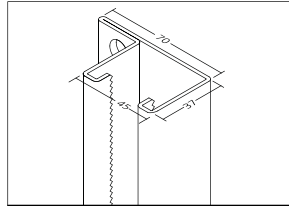

Ref:	Description
901201	Toothed track, Inside. 4500mm

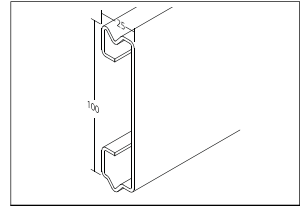

Ref:	Description
901202	Slat 4500mm

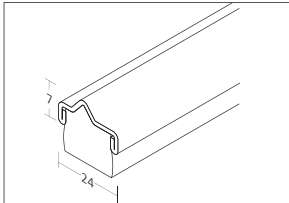

Ref:	Description
901208	Slide Rail. 4500mm

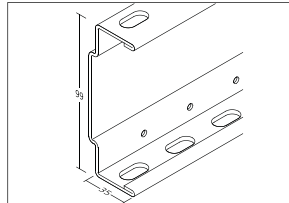

Ref:	Description
901203	Strengthening Beam. 4500mm

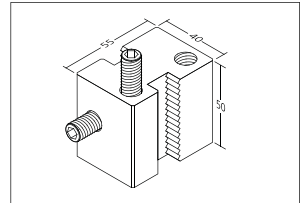

Ref:	Description
905200	Clamp

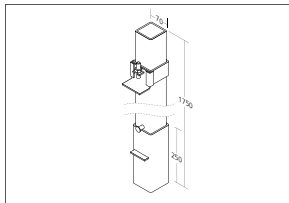

Ref:	Description
901204	Medium Post.

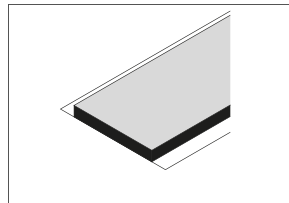

Ref:	Description
905206	Toothed track seal

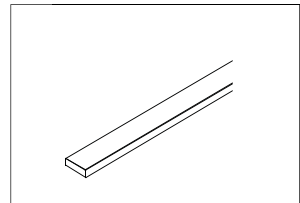

Ref:	Description
905202	Slat seal

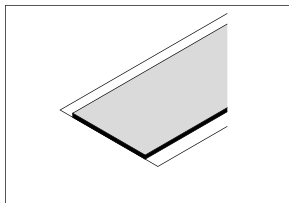

Ref:	Description
905205	Closing seal. (Track band)

SIMPLE INSTALLATION

Manufactured in galvanised steel, the guide tracks, glued with a seal and pre-drilled, are secured with dowels next to the opening or in the reveal and sealed at the base.

The slats are then adjusted to length and prepared seals are stuck on and are slotted into the lateral tracks, tightened with the two clamps and the vertical connection points are sealed.

STAINLESS BALUSTRADE

SECTION GUIDE

STAINLESS STEEL BALUSTRADE	37
FRAMELESS GLASS BALUSTRADE.....	46
BALUSTRADE MESH	51



STAINLESS BALUSTRADE TUBES & SLOTTED TUBES

STAINLESS STEEL, ORNAMETAL

6m Length, 320 Grain

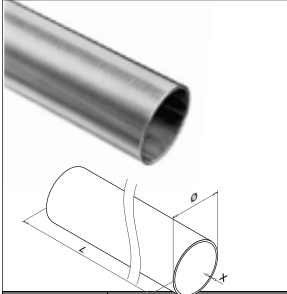

Dia	Grade
42.4x2.0	304/316
42.4x2.5	304/316
48.3x2.0	304/316
48.3x2.5	304/316
50.8x3.0	304/316
60.3x3.0	304/316

STAINLESS STEEL SLOTTED

6m Length, 320 Grain

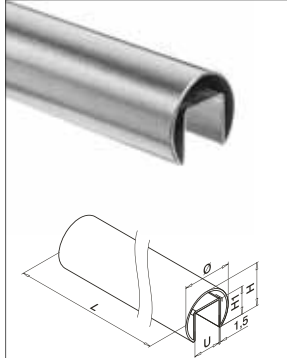

Dia	Slot UxH1	Grade
42.4x1.5	24x24	304/316
48.3x1.5	27x30	304/316
60.3x1.5	34x34	304/316

STAINLESS STEEL RECTANGULAR

6m Length, 320 Grain

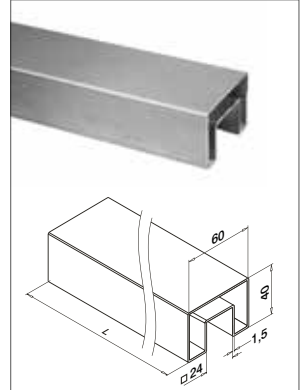

WxH	Slot	Grade
40x40x1.5	24x24	304/316
60x40x1.5	24x24	304/316

STAINLESS STEEL OVAL

6m Length, 320 Grain

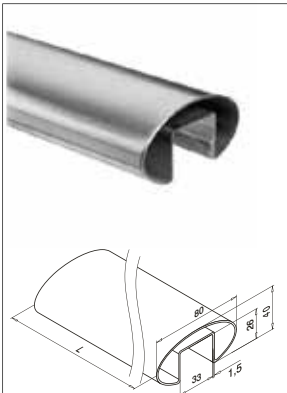

Dia WxH	Slot	Grade
80x40x1.5	33x26	304/316

TIMBER TOP RAIL

2.5m Length

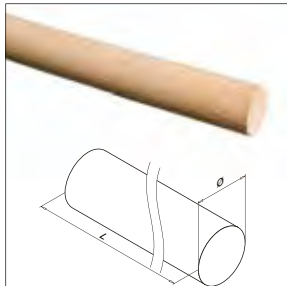

Dia	Slot	Material
Any	Slotted or Round	Beech, Oak or Cedar

K005 STAINLESS STEEL CAPPING

3m Length, 320 Grain

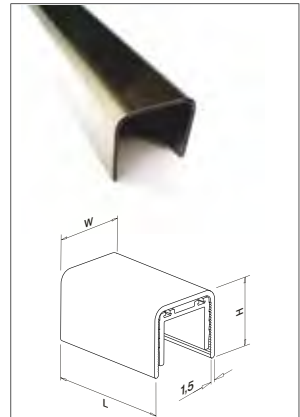

WxH	Slot	Grade	Glass
27.7x25.1	24x24	304/316	12-21.5

STAINLESS BALUSTRADE BASE PLATES, COVERS & STEMS

BASE PLATE REINFORCED

120 Dia.

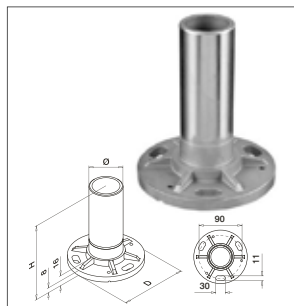

Ref	Dia	D1/H
90942/M12.420.34	38.3	120 / 117
90942/M12.425.34	38.3	120 / 117
90942/M12.485.34	44.2	120 / 117
90942/M12.420.36	38.3	120 / 117
90942/M12.425.36	38.3	120 / 117
90942/M12.485.36	44.2	120 / 117

BASE PLATE WELD ON

M12 - 120 Dia.

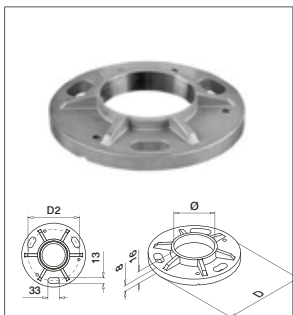

Ref	Dia	D1/H
90941/M12.42.34	42	120 / 90
90941/M12.48.34	48	120 / 90
90941/M12.42.36	42	120 / 90
90941/M12.48.36	48	120 / 90

CLICK-ON COVER

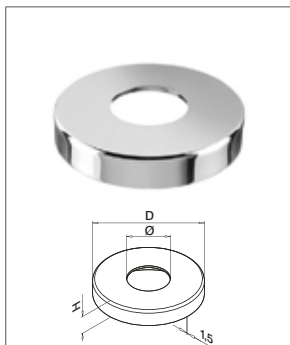

Ref	Dia	D
90513.42.34	42	125
90513.48.34	48	125
90513.42.36	42	125
90513.48.36	48	125

POST STEM / ARTICULATED SADDLE

42.4mm UPRIGHT

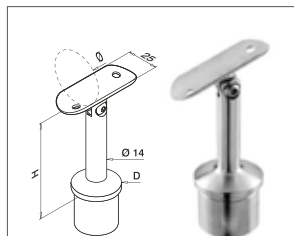

Ref	D/Dia	H
90718.420.42.34	42.4 x 2 / 42	79
90718.420.48.34	42.4 x 2 / 48	80
90718.425.42.34	42.4 x 2.5 / 42	79
90718.425.48.34	42.4 x 2.5 / 48	80
90718.420.42.36	42.4 x 2 / 42	79
90718.420.48.36	42.4 x 2 / 48	80
90718.425.42.36	42.4 x 2.5 / 42	79
90718.425.48.36	42.4 x 2.5 / 48	80

POST STEM / ARTICULATED SADDLE

48.3mm UPRIGHT

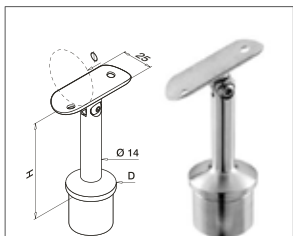

Ref	D/Dia	H
90719.480/42.34	48.3 x 2.0 / 42	79
90719.485.42.34	48.3 x 2.5 / 42	79
90719.485.48.34	48.3 x 2.5 / 48	80
90719.480/42.36	48.3 x 2.0 / 42	79
90719.485.42.36	48.3 x 2.5 / 42	79
90719.485.48.36	48.3 x 2.5 / 48	80

STAINLESS BALUSTRADE GLASS CLAMPS

MIDDLE D GLASS CLAMP

To suit 10, 12 & 13.5mm Glass

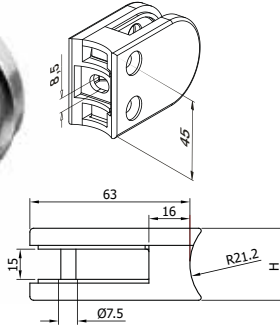

Includes M6 Screw, End Cap, Safe Pin
+ Rubbers (10, 12 & 13.5mm)

4 per box.

ZA codes denote ZAMAC

ZASS codes denote ZAMAC Stainless Steel finish

Ref	Dia	H
92210/12.00.34F	FLAT	30
92210/12.42.34	42	30
92210/12.48.34	48	30
92210/12.00.36F	FLAT	30
92210/12.42.36	42	30
92210/12.48.36	48	30

Ref	Dia	H
92210.00.ZAF	FLAT	28
92210.42.ZA	42	28
92210.48.ZA	48	28
92210.00.ZASSF	FLAT	28
92210.42.ZASS	42	28
92210.48.ZASS	48	28

LARGE MIDDLE D GLASS CLAMP

To suit 15-19mm Glass

LARGE MIDDLE D GLASS CLAMP

To suit 21-25.5mm Glass

**HUGE
TRADE
DISCOUNT**

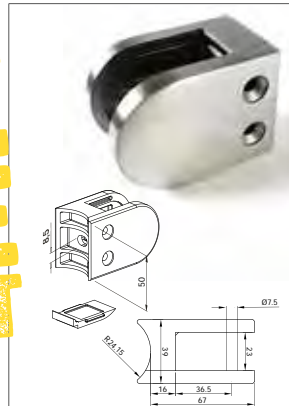

Ref	Dia	WxHxB
92812.00.36F	FLAT	67x50x39
92812.48.36	48	67x50x39

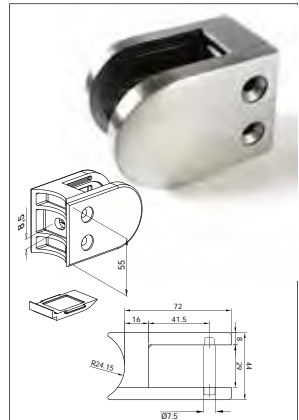

Ref	Dia	WxHxB
92912.00.36F	FLAT	72 x 55 x 45
92912.48.36	48	72 x 55 x 45

STAINLESS BALUSTRADE ELBOWS

90° ACUTE ELBOW

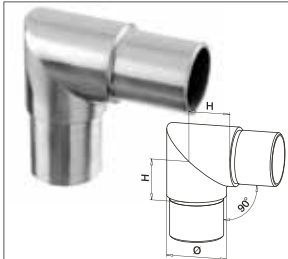

Ref	Dia	H
90301.420.34	42.4 x 2.0	30
90301.425.34	42.4 x 2.5	30
90301.480.34	48.3 x 2.0	35
90301.485.34	48.3 x 2.5	35
90301.420.36	42.4 x 2.0	30
90301.425.36	42.4 x 2.5	30
90301.480.36	48.3 x 2.0	35
90301.485.36	48.3 x 2.5	35

90° SWEEPING ELBOW

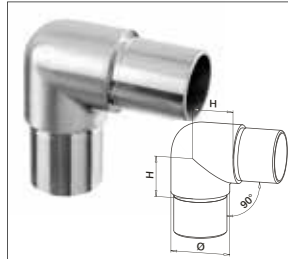

Ref	Dia	H
90303.420.34	42.4 x 2.0	30
90303.425.34	42.4 x 2.5	30
90303.480.34	48.3 x 2.0	35
90303.485.34	48.3 x 2.5	35
90303.420.36	42.4 x 2.0	30
90303.425.36	42.4 x 2.5	30
90303.480.36	48.3 x 2.0	35
90303.485.36	48.3 x 2.5	35

TUBE CONNECTOR

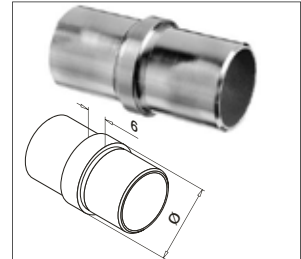

Ref	Dia	H
90790.420.34	42.4 x 2.0	30
90790.425.34	42.4 x 2.5	30
90790.480.34	48.3 x 2.0	35
90790.485.34	48.3 x 2.5	35
90790.420.36	42.4 x 2.0	30
90790.425.36	42.4 x 2.5	30
90790.480.36	48.3 x 2.0	35
90790.485.36	48.3 x 2.5	35

90° TUBE END

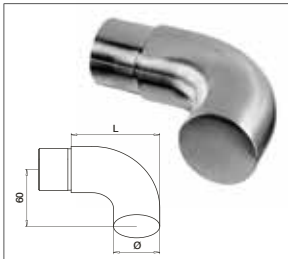

Ref	Dia	H
90739.420.34	42.4 x 2.0	30
90739.425.34	42.4 x 2.5	30
90739.480.34	48.3 x 2.0	35
90739.485.34	48.3 x 2.5	35
90739.420.36	42.4 x 2.0	30
90739.425.36	42.4 x 2.5	30
90739.480.36	48.3 x 2.0	35
90739.485.36	48.3 x 2.5	35

90° WELDED ELBOW

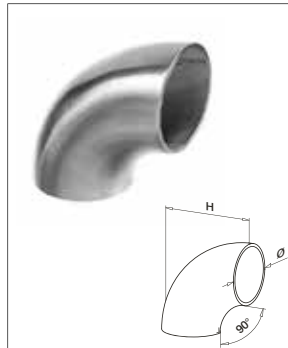

Ref	Dia	H
91305.420.34	42.4 x 2.0	70
91305.485.34	48.3 x 2.5	80
91305.420.36	42.4 x 2.0	70
91305.485.36	48.3 x 2.5	80

MORE THAN STEEL

STAINLESS BALUSTRADE END CAPS & WALL BRACKETS

END CAP RADIUSED

Push-In

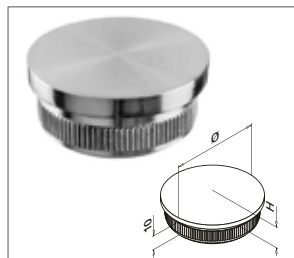

Ref	Dia	H
95729.420.34	42.4 x 2.0	6
95729.425.34	42.4 x 2.5	6
95729.480.34	48.3 x 2.0	6
95729.485.34	48.3 x 2.5	6
95729.420.36	42.4 x 2.0	6
95729.425.36	42.4 x 2.5	6
95729.480.36	48.3 x 2.0	6
95729.485.36	48.3 x 2.5	6

HANDRAIL WALL BRACKET

Weld-On - 60mm Dia

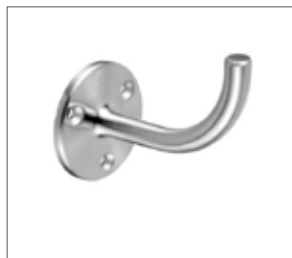

Ref	LH
90109.00.34	86 / 57
90109.00.36	86 / 57

COVER WALL BRACKET

To Suit 90109



Ref	Dia	H
90519.00.36	12	65 x 16

HANDRAIL WALL BRACKET

Fixed Saddle - 60mm Dia.

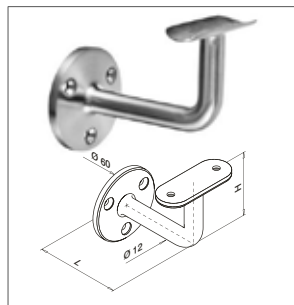

Ref	Dia	H
90101.00.34F	FLAT	86 / 57
90101.42.34	42	86 / 57
90101.48.34	48	86 / 57
90101.00.36F	FLAT	86 / 57
90101.42.36	42	86 / 57
90101.48.36	48	86 / 57

FOR A FAST,
COMPETITIVE QUOTE
CALL NOW!

STAINLESS BALUSTRADE GLASS BRACKETS

ARTICULATED OFFSET BRACKET

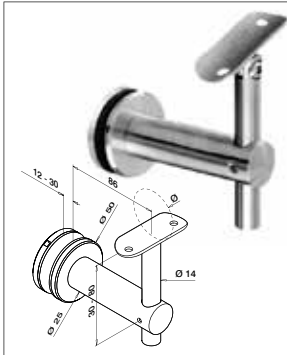

Ref	Dia	L
90155.42.34	42	86
90155.48.34	48	86
90155.42.36	42	86
90155.48.36	48	86

ARTICULATED OFFSET BRACKET



Ref	Dia	L/H
90117.00.34F	FLAT	86 / 57
90117.42.34	42	86 / 57
90117.48.34	48	86 / 57
90117.00.36F	FLAT	86 / 57
90117.42.36	42	86 / 57
90117.48.36	48	86 / 57

WALL BRACKET

External

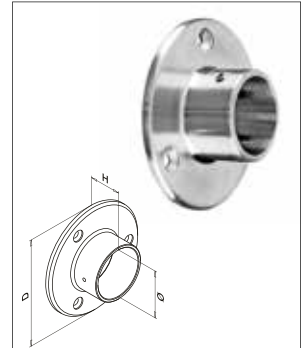

Ref	Dia	D/H
90505.42.34	42	86 / 57
90505.48.34	48	86 / 57
90505.42.36	42	86 / 57
90505.48.36	48	86 / 57

FIXED SLAB BRACKET

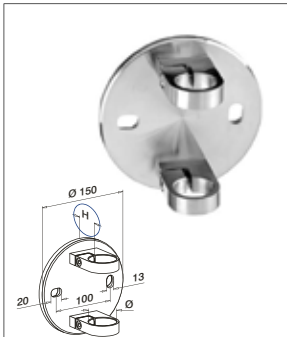

Ref	Dia	H
90551.42.34	42	45
90551.48.34	48	45
90551.42.36	42	45
90551.48.36	48	45

MORE THAN STEEL

STAINLESS BALUSTRADE STAIR & SLAB ADAPTORS

HUGE TRADE DISCOUNT

GLASS ADAPTOR M12

50mm Dia

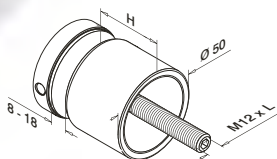

Ref	H/L	Glass
90747.10.34F	10/50	8-17.53
90747.20.34	20/70	8-17.53
90747.30.34	30/80	8-17.53
90747.40.34	40/80	8-17.53
90747.50.34	50/90	8-17.53
90747.100.34	100/90	8-25.5

Ref	H/L	Glass
90747.10.36F	10/50	8-17.53
90747.20.36	20/70	8-17.53
90747.30.36	30/80	8-17.53
90747.40.36	40/80	8-17.53
90747.50.36	50/90	8-17.53
90747.100.36	100/90	8-25.5

SLAB CONNECTOR

50mm Dia

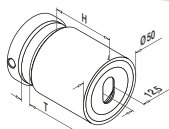
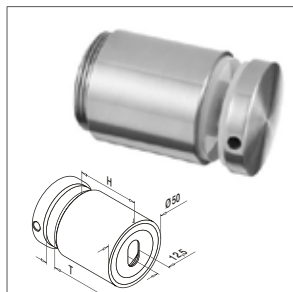

Ref	Dia	Glass
90749.30.34	30	8-18
90749.40.34	40	8-21.5
90749.50.34	50	8-21.5
90749.30.36	30	8-18
90749.40.36	40	8-21.5
90749.50.36	50	8-21.5

ROUND SPIGOT

50mm Dia

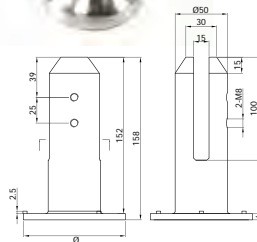

Ref	Dia	Glass
90099.36	100	12 & 13.5

JULIET BRACKET

M10 x 300mm

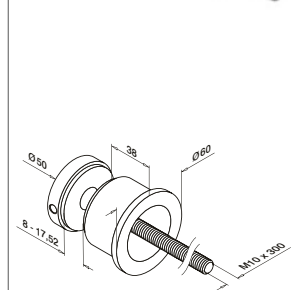

Ref	LH
90748.00.36	50

STAINLESS BALUSTRADE SLOTTED TUBE FITTINGS

END CAP

For Slotted Tube



Ref	Dia	H
96732.42.34	42	4
96732.48.34	48	4
96732.60.34	60	4
96732.42.36	42	4
96732.48.36	48	4
96732.60.36	60	4

TUBE CONNECTOR

For Slotted Tube

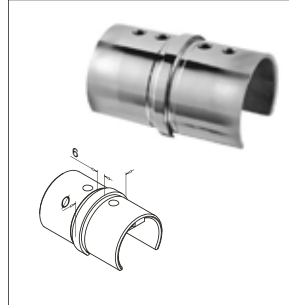

Ref	Dia	L/H
96790.42.34	42	6
96790.48.34	48	6
96790.60.34	60	6
96790.42.36	42	6
96790.48.36	48	6
96790.60.36	60	6

90° HORIZONTAL CONNECTOR

For Slotted Tube

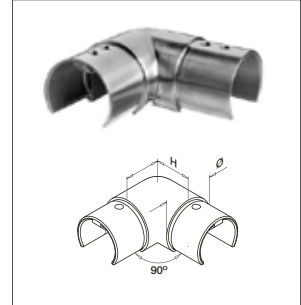

Ref	Dia	D/H
96313.42.34	42	30
96313.48.34	48	35
96313.60.34	60	40
96313.42.36	42	30
96313.48.36	48	35
96313.60.36	60	40

WALL BRACKET

For Slotted Tube

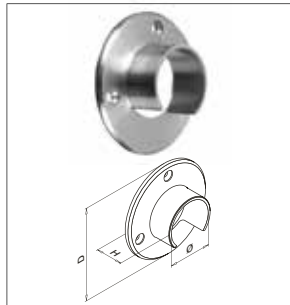

Ref	Dia	D/H
96505.42.34	42	30
96505.48.34	48	30
96505.60.34	60	30
96505.42.36	42	30
96505.48.36	48	30
96505.60.36	60	30

'U' RUBBER GASKET

6M Roll

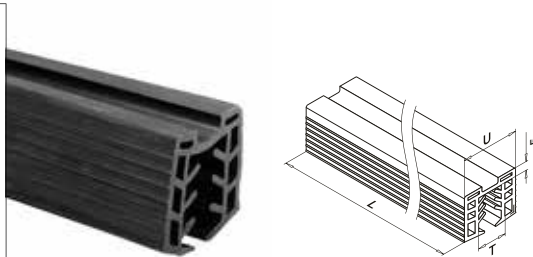

Ref	Dia	H
950.42.110	24	10-12.5
950.42.120	24	11.5-13.5
950.42.150	24	15
950.42.175	24	16-17.5
950.42.190	24	19
950.42.215	24	20-21.5

Ref	Dia	H
950.48.110	27	10-12.5
950.48.120	27	11.5-13.5
950.48.150	27	15
950.48.175	27	16-17.5
950.48.190	27	19
950.48.215	27	20-21.5



**EASYFIT GLASS
BALUSTRADE
SYSTEMS.**

**SIMPLE
INSTALLATION
FOR INDOOR
& OUTDOOR
PROJECTS.**

**FOR A FAST,
COMPETITIVE QUOTE
CALL NOW!**

BALUSTRADE FRAMELESS GLASS BALUSTRADE EAZYFIT 1.5K SG

- Only adjustable clamp system: Easy to line-up glass
- Tested up to 1.5Kn (BS 6180)
- Dry-glazed clamp system for clean and fast installation (no epoxy sealant required) and easy replacement of broken glass panels
- Cost effective: Reduced labour time on site (Fixed every 200mm)
- Light-weight & Pre-drilled profiles: Off-the-shelf kit
- Available as Base or Side Fix to suit 12 to 21.5mm glass
- Suitable for indoor and outdoor applications (totally anodised extrusion)
- Top rail (slotted tube), gaskets and connectors available ex-stock



EASY ASSEMBLY



COST EFFECTIVE



INDOOR & OUTDOOR

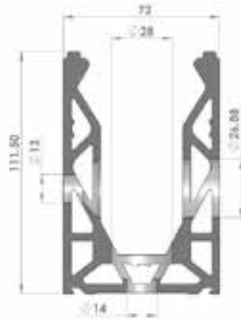
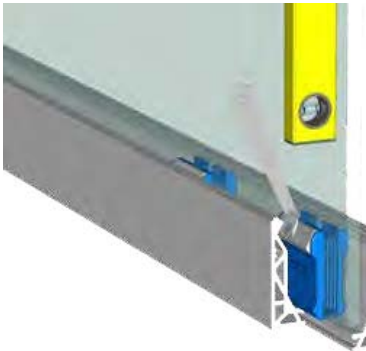

Side Fixing



Base Fixing



Residential Project
St Brelade, Jersey

MORE THAN STEEL

BALUSTRADE FRAMELESS GLASS BALUSTRADE EAZYFIT 1.5K SG

- Fully tested system for domestic and residential projects; Offices and working environment (incl. storage), restaurant & bars

Concrete Based Fixed Anchoring System

Aluminium shoe base bolted down into concrete at 200mm centres with Spit Guardia 12 x 105/20 fixings.



Glass	12mm	13.5mm SG	15mm	17.5mm SG	19mm	21.5mm EVA	21.5mm SG
.36 kN/m	✓	✓					
.74 kN/m			✓	✓	✓	✓	✓
1.5 kN/m					✓		✓

Concrete Based Fixed Anchoring System

Aluminium shoe base bolted down into concrete at 200mm centres with Spit Guardia 12 x 105/20 fixings.

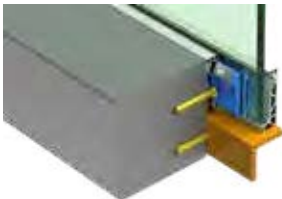

Glass	12mm	15mm	19mm	21.5mm SG
.36 kN/m	✓		✓	
.74 kN/m		✓	✓	✓
1.5 kN/m				

Steel Based Fixed Anchoring System

Aluminium shoe base bolted down into steel at 200mm centres with M12 - 10.9 fixings.

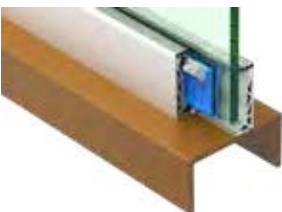

Glass	12mm	13.5mm SG	15mm	17.5mm SG	19mm	21.5mm EVA	21.5mm SG
.36 kN/m	✓	✓					
.74 kN/m			✓	✓	✓	✓	✓
1.5 kN/m					✓		✓

Steel Based Fixed Anchoring System

Aluminium shoe base bolted down into steel at 200mm centres with M12 - 10.19 fixings.

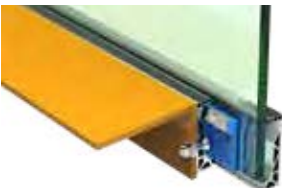

Glass	15mm	19mm	21.5mm EVA	21.5mm SG
.36 kN/m	✓		✓	✓
.74 kN/m	✓	✓	✓	✓
1.5 kN/m				

BALUSTRADE FRAMELESS GLASS BALUSTRADE EAZYFIT 1.5K SG

Off the shelf kit for short lead time installation, Base Fixed.









Base - Fixed		Glass Thickness				
Details	Image	12mm	15mm	19mm	21.5mm EVA	21.5mm Sentry Glass
MAGEF - 9002 EFBF Pre-drilled base fixed (6m length)		1 x	1 x	1 x	1 x	1 x
MAGEF - 9004 Aluminium Bead (3m length)		2 x	2 x	2 x	2 x	2 x
MAGBA - 9504 End Cap Base Fixed for bead both sides		(a)	(a)	(a)	(a)	(a)
MAGEF - 9005 Side Fixed Cladding (3m length)		2 x	2 x	2 x	2 x	2 x
MAGBA - 9508 End Cap Base Fixed for bead one side & cladding other side		(a)	(a)	(a)	(a)	(a)
MAGBA - 9509 End Cap Base Fixed for cladding both sides		(a)	(a)	(a)	(a)	(a)
Glass Clamp Kit (12 x pack) including 6mm gasket for 9004/5 (1 pack per 3m)		1 x 94120	1 x 94150	1 x 94190	1 x 94210	1 x 94210
MAGBA - 9507 Channel Connectors (Dowel) 2 per connection		tba	tba	tba	tba	tba
MAGBA - 9506 Spanner (10mm head)		1 x	1 x	1 x	1 x	1 x
Option: MAGEF 90.9002 Corner		1 x	1 x	1 x	1 x	1 x

(a) - Choose one of three caps.

MORE THAN STEEL

BALUSTRADE FRAMELESS GLASS BALUSTRADE EAZYFIT 1.5K SG

Off the shelf kit for short lead time installation, Side Fixed.

Side - Fixed		Glass Thickness				
Details	Image	12mm	15mm	19mm	21.5mm EVA	21.5mm Sentry Glass
MAGEF - 9003 EFSF Pre-drilled side fixed (6m length)		1 x	1 x	1 x	1 x	1 x
MAGEF - 9004 Aluminium Bead (3m length)		1 x	1 x	1 x	1 x	1 x
MAGEF - 9005 Side Fixed Cladding (3m length)		1 x	1 x	1 x	1 x	1 x
MAGBA - 9508 End Cap Base Fixed for bead one side & cladding other side		(a)	(a)	(a)	(a)	(a)
MAGEF - 9006 Side Fixed Bottom Cover (3m length)		1 x	1 x	1 x	1 x	1 x
MAGBA - 9505L / 9505R End Cap Side Fixed (to be used with 9006)		(a)	(a)	(a)	(a)	(a)
Glass Clamp Kit (12 x pack) including 6mm gasket for 9004/5 (1 pack per 3m)		1 x 94120	1 x 94150	1 x 94190	1 x 94210	1 x 94210
MAGBA - 9507 Channel Connectors (Dowel) 2 per connection		tba	tba	tba	tba	tba
MAGBA - 9506 Spanner (10mm head)		1 x	1 x	1 x	1 x	1 x

(a) - Choose one of three caps.

BALUSTRADE MESH



Architectural woven wire mesh contains a wide variety of textures and patterns that are meant to be as beautiful as they are functional.

Available in **Stainless, Mild Steel, Aluminium, Bronze, Brass, Copper, Galv or Galfan**
 - Please specify when ordering.

Pre-crimped woven wire mesh is constructed of wires that have been crimped prior to weaving them together in a loom. Crimping the wires before weaving provides stability and consistency in larger spaced wire mesh. Various crimping styles have been developed over the years to improve manufacturing efficiencies, function, and aesthetics.

Suitable for the following applications: Balustrades, Wall Cladding/Facades, Interior Design, Partitions and Fencing.



BM-962

SPECIFICATIONS

Percent open area	81.7%
Weight Kg/M ²	5.86
Opening Limitation	46.0mm
Overall Thickness	9.6mm
Aspect Ratio	1.00:1
Crimp Style	LCLC

Ref	Stock Size
BM962-1000	1000 x 2000mm
BM962-1250	1250 x 2500mm
BM962-1500	1500 x 3000mm



BM-944-2

Percent open area	77.4%
Weight Kg/M ²	5.07
Opening Limitation	50.8mm
Overall Thickness	6.9mm
Aspect Ratio	1.00:1
Crimp Style	4L4L

Ref	Stock Size
BM9442-1000	1000 x 2000mm
BM9442-1250	1250 x 2500mm
BM9442-1500	1500 x 3000mm



EAZYDECK **COMPOSITE** **DECKING SYSTEM**

See page 74 for details

15 year residential, 10 year
commercial limited warranty

Non-slip surface

Reversible finish (soft
grain and grooved)

Manufactured 90% recycled material

Concealed safety securing
clips and fastening system

NEW!
PRODUCT
LINE.

SPECIFICATIONS

Percent open area	62.9%
Weight Kg/M ²	8.06
Opening Limitation	6.76mm
Overall Thickness	7.7mm
Aspect Ratio	8.16:1
Crimp Style	PS3PZ

Ref	Stock Size
BM913Z-1000	1000 x 2000mm
BM913Z-1250	1250 x 2500mm
BM913Z-1500	1500 x 3000mm



Percent open area	51.1%
Weight Kg/M ²	7.32
Opening Limitation	23.8mm
Overall Thickness	3.8mm
Aspect Ratio	1.00:1
Crimp Style	E3E3

Ref	Stock Size
BM9S15-1000	1000 x 2000mm
BM9S15-1250	1250 x 2500mm
BM9S15-1500	1500 x 3000mm

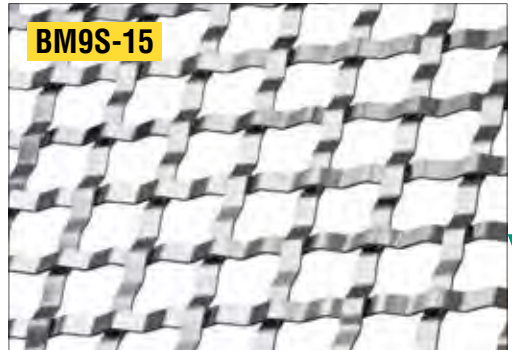

Percent open area	74.8%
Weight Kg/M ²	6.00
Opening Limitation	22.0mm
Overall Thickness	8.6mm
Aspect Ratio	1.00:1
Crimp Style	TSLCZ

Ref	Stock Size
BM913-1000	1000 x 2000mm
BM913-1250	1250 x 2500mm
BM913-1500	1500 x 3000mm



MORE THAN STEEL

WALKWAY PRODUCTS

SECTION GUIDE

UTILITY FLOORING	55
BALL PROOF FLOORING	58
PRESS LOCKED FLOORING	61
KICK-FLAT AND FIXINGS	63
STAIR TREADS	64
PERFORATED PLANKS	65
FLOOR PLATES, CHEQUER	66
TREAD PLATES AND NOSING	
TREAD PLATES, ALUMINIUM	67
& STAINLESS	
GRP-WALKWAY & CLIPS	68
EXPANDED METAL WALKWAY	70
ARMCO CRASH BARRIER	71
EAZY DECK COMPOSITE DECKING	74

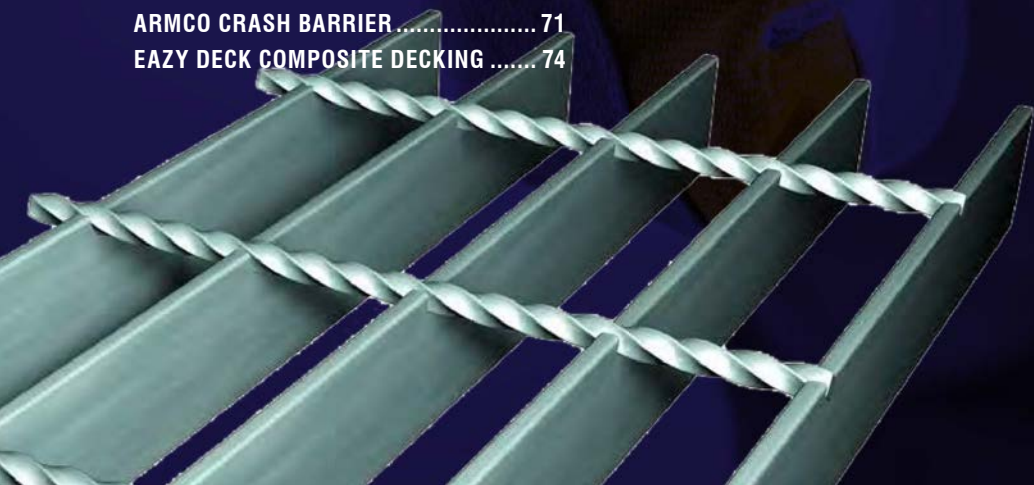

UTILITY FLOORING

OPEN STEEL FLOOR

- Standard range of panels: 6 x 1m (nominal size)
- Panels can be cut and shaped to bespoke requirements
- Available in the following finishes; Plain | Rolled Serrated | Machine Serrated

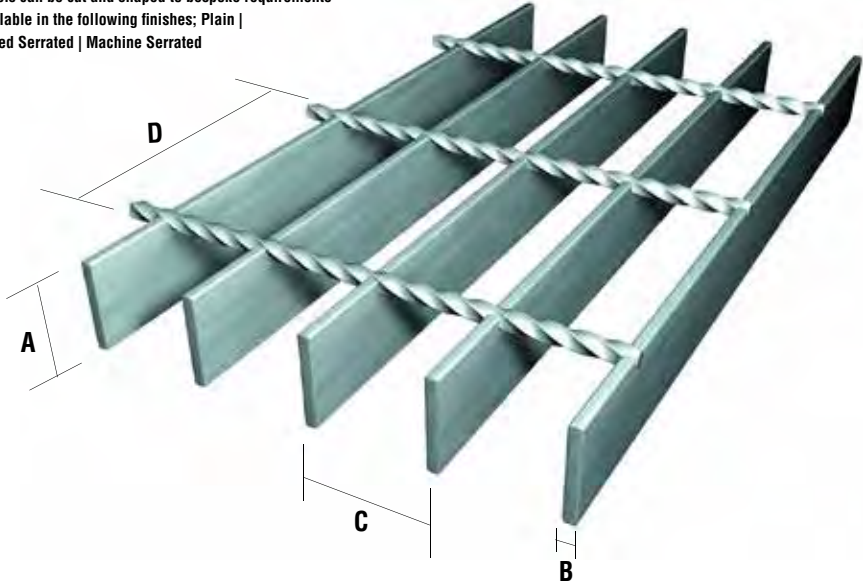

SPECIFICATION ARRANGEMENT TABLE

DIMENSIONS			
A	B	C	D
20	3	30/41	50/ 100
25	3		
25	5		
30	3		
30	5		
35	3		
35	5		
40	3		
40	5		

Load Table Guideline	
Load	Application
3kN/M ²	Access limited to one person
5kN/M ²	Two way pedestrian traffic
7.5kN/M ²	High density pedestrian traffic

Please refer to detailed load tables overleaf for each arrangement.

Available in SELF COLOUR or GALVANISED

MORE THAN STEEL

BALL PROOF FLOORING STEEL FLOOR

**SPECIFICATION TO:
BS4592-0:216+A1:2012**

**IF YOU SPECIFY, DISTRIBUTE, PURCHASE, FABRICATE, INSTALL
STEEL GRATINGS, YOU HAVE A RESPONSIBILITY TO PROVIDE
COMPLIANT PRODUCTS TO THE LATEST SPECIFICATION.**



20mm BALL PROOF GRATING

To be used where the working platform or walkway is above a place where people are working

The maximum openings shall not permit the passage of a 20mm diameter sphere. Typically used on walkways above machinery and permanent working areas, where the risk to personnel from large objects, falling from above, is critical

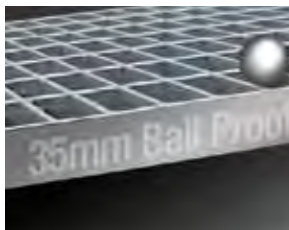

35mm BALL PROOF GRATING

To be used where the working platform or walkway is above a place where people pass through occasionally, the maximum openings shall not permit the passage of a 35mm diameter sphere.

Typically used on maintenance access, industrial plants, un-manned substation modules, data centres, where site access is limited and occasional.



UTILITY GRATING

To be used where there is no risk of personnel passing below the working platform or walkway.

Typically used on ground level shallow trenches, above water channels in treatment works or placed on solid floors to elevate walking areas from contaminants.

BALL PROOF FLOORING LOAD TABLES

3mm - 20mm BALL PROOF GRATING (MESH SIZE 21/100)

Bearing Bar Dimensions (mm)	Loading Category	Max Clear Span 4mm Deflection	Deflection (mm)	Max Clear Span L/200 or 10mm Max Deflection	Deflection (mm)	Self Colour Weights Per Square Metre (kgs)	Binding Bar Weight Based on 2x1m (kgs)
25 x 3	5kn/m ²	1075	3.98	1300	6.16	30.49	1.18
	7.5kn/m ²	1055	3.99	1155	5.73		
30 x 3	5kn/m ²	1305	4.00	1580	7.90	36.03	1.41
	7.5kn/m ²	1210	3.98	1390	6.90		
35 x 3	5kn/m ²	1535	3.99	1840	9.17	41.56	1.65
	7.5kn/m ²	1355	3.94	1620	8.05		
40 x 3	5kn/m ²	1655	4.00	2080	9.98	47.09	1.88
	7.5kn/m ²	1505	4.00	1855	9.23		

BALL PROOF FLOORING

LOAD TABLES CONT.

3mm - 35mm BALL PROOF GRATING (MESH SIZE 37/125)

25 x 3	5kn/m ²	875	3.99	930	4.61	18.74	1.18
	7.5kn/m ²	875	3.99	930	4.61		
30 x 3	5kn/m ²	1060	4.00	1170	5.05	22.03	1.41
	7.5kn/m ²	1060	4.00	1170	5.82		
35 x 3	5kn/m ²	1240	3.96	1420	5.43	25.33	1.65
	7.5kn/m ²	1195	3.97	1365	6.77		
40 x 3	5kn/m ²	1430	3.98	1700	7.35	28.63	1.88
	7.5kn/m ²	1320	3.95	1565	7.79		

3mm - UTILITY GRATING (MESH SIZE 47/125)

25 x 3	5kn/m ²	775	3.69	775	3.69	15.20	1.18
	7.5kn/m ²	775	3.69	775	3.69		
30 x 3	5kn/m ²	965	3.98	1035	4.70	17.79	1.41
	7.5kn/m ²	965	3.98	1035	4.70		
35 x 3	5kn/m ²	1135	3.99	1255	5.05	20.38	1.65
	7.5kn/m ²	1125	3.99	1255	6.17		
40 x 3	5kn/m ²	1305	3.98	1495	5.46	22.97	1.88
	7.5kn/m ²	1245	3.98	1440	7.12		

5mm - 20mm BALL PROOF GRATING (MESH SIZE 23/100)

Bearing Bar Dimensions (mm)	Loading Category	Max Clear Span 4mm Deflection	Deflection (mm)	Max Clear Span L/200 or 10mm Max Deflection	Deflection (mm)	Self Colour Weights Per Square Metre (kgs)	Binding Bar Weight Based on 2x1m (kgs)
25 x 5	5kn/m ²	1290	3.90	1525	7.62	45.01	1.96
	7.5kn/m ²	1180	3.98	1340	6.63		
30 x 5	5kn/m ²	1485	3.98	1825	9.09	53.45	2.36
	7.5kn/m ²	1350	3.95	1610	8.00		
35 x 5	5kn/m ²	1665	4.00	2090	9.91	61.89	2.75
	7.5kn/m ²	1515	3.96	1880	9.39		
40 x 5	5kn/m ²	1830	3.94	2305	9.92	70.33	3.14
	7.5kn/m ²	1675	3.98	2105	9.94		
45 x 5	5kn/m ²	2005	3.97	2525	9.99	78.77	3.53
	7.5kn/m ²	1830	3.97	1205	9.99		
50 x 5	5kn/m ²	2160	4.00	2715	9.98	87.21	3.93
	7.5kn/m ²	1975	3.99	2485	9.99		
60 x 5	5kn/m ²	2460	3.98	3095	9.98	104.09	4.71
	7.5kn/m ²	2255	3.98	2835	9.95		

MORE THAN STEEL

BALL PROOF FLOORING LOAD TABLES CONT.

5mm - 35mm BALL PROOF GRATING (MESH SIZE 38/125)

Bearing Bar Dimensions (mm)	Loading Category	Max Clear Span 4mm Deflection	Deflection (mm)	Max Clear Span L/200 or 10mm Max Deflection	Deflection (mm)	Self Colour Weights Per Square Metre (kgs)	Binding Bar Weight Based on 2x1m (kgs)
25 x 5	5kn/m ²	1145	3.99	1310	6.51	28.74	1.96
	7.5kn/m ²	1050	3.96	1150	5.70		
30 x 5	5kn/m ²	1330	4.00	1575	7.86	34.04	2.36
	7.5kn/m ²	1205	3.96	1385	6.91		
35 x 5	5kn/m ²	1490	3.97	1835	9.13	39.34	2.75
	7.5kn/m ²	1355	3.98	1615	8.03		
40 x 5	5kn/m ²	1645	3.97	2070	9.96	44.64	3.14
	7.5kn/m ²	1495	3.95	1845	9.18		
45 x 5	5kn/m ²	1800	3.98	2265	9.98	49.64	3.53
	7.5kn/m ²	1635	3.96	2060	9.98		
50 x 5	5kn/m ²	1940	3.98	2440	9.95	55.24	3.93
	7.5kn/m ²	1765	3.96	2225	9.99		
60 x 5	5kn/m ²	2200	4.00	2790	9.98	65.84	4.71
	7.5kn/m ²	2020	3.96	2545	9.98		

5mm - UTILITY GRATING (MESH SIZE 47/125)

Bearing Bar Dimensions (mm)	Loading Category	Max Clear Span 4mm Deflection	Deflection (mm)	Max Clear Span L/200 or 10mm Max Deflection	Deflection (mm)	Self Colour Weights Per Square Metre (kgs)	Binding Bar Weight Based on 2x1m (kgs)
25 x 5	5kn/m ²	1050	3.98	1224	6.10	23.84	1.96
	7.5kn/m ²	995	3.92	1075	5.34		
30 x 5	5kn/m ²	1265	4.00	1470	7.29	28.16	2.36
	7.5kn/m ²	1145	3.96	1290	6.38		
35 x 5	5kn/m ²	1415	3.95	1715	8.52	32.47	2.75
	7.5kn/m ²	1285	3.95	1510	7.53		
40 x 5	5kn/m ²	1565	3.97	1960	9.77	36.79	3.14
	7.5kn/m ²	1420	3.95	1725	8.59		
45 x 5	5kn/m ²	1710	3.96	2155	9.98	41.11	3.53
	7.5kn/m ²	1555	3.97	1955	9.91		
50 x 5	5kn/m ²	1850	3.99	2325	9.97	45.43	3.93
	7.5kn/m ²	1680	3.97	2115	9.97		
60 x 5	5kn/m ²	2115	3.99	2660	9.98	54.06	4.71
	7.5kn/m ²	1925	3.98	2420	9.95		

PRESS LOCKED GRATING

VERSATILE & DURABLE

**NEW!
PRODUCT
LINE.**

Press-locked steel grating also known as pressure locked grating. The grating is made of mild carbon steel, stainless steel or aluminium. With high load bearing capacity, non-slip, anti-corrosion and easy to install, pressure locked grating is versatile and can be used for flooring, fences, in-fill and all kinds of cover in the factories, civil and commercial buildings.

Key benefit is that in normal circumstances, there is hardly any scrap or wastage from Gross sizes as you produce to the length and width dimensions required.



Bearing Bars mm		Mesh Pitch		Material
Thickness (t)	Height (h)	Bearing Bar Width (a)	Cross Bar Width (a)	
2 x	20	11,11	11,11	S 235 JR 1.4301 1.4404 1.4571
	25	22,22	22,22	
	30	33,33	33,33	
	35	55,55	55,55	
	40	66,66	66,66	
3 x	50	Further pitches are available on request.		Additional serrations possible in bearing and/or cross bar. Designs available on request, e.g. trapezoid.
	60			
	20			
	25			
	30			
	35			
	40			
	50			
60				

Load tables overleaf.

MORE THAN STEEL

PRESSLOCK FLOORING

LOAD TABLE

*span (mm)	20 x 2		25 x 2		30 x 2		35 x 2		40 x 2		50 x 2	
	Fp	Fv	Fp	Fv	Fp	Fv	Fp	Fv	Fp	Fv	Fp	Fv
300	3,58	51,20	5,55	80,00	7,92	115,20	10,68	156,80	13,82	204,80	21,19	320,00
400	2,39	28,80	3,70	45,00	5,28	64,80	7,12	88,20	9,22	115,20	14,13	180,00
500	1,79	18,43	2,78	28,80	3,96	41,47	5,34	56,45	6,91	73,73	10,60	115,20
600	1,43	12,80	2,22	20,00	3,17	28,80	4,27	39,20	5,53	51,20	8,48	80,00
700	1,19	9,40	1,85	14,69	2,64	21,16	3,56	28,80	4,61	37,62	7,06	58,78
800	0,91	6,30	1,59	11,25	2,26	16,20	3,05	22,05	3,95	28,80	6,05	45,00
900	0,71	4,42	1,38	8,64	1,98	12,80	2,67	17,42	3,46	22,76	5,30	36,56
1000	0,58	3,23	1,11	6,30	1,76	10,37	2,37	14,11	3,07	18,43	4,71	28,80
1100	0,47	2,42	0,92	4,73	1,57	8,18	2,14	11,66	2,76	15,23	4,24	23,80
1200	0,40	1,87	0,77	3,65	1,32	6,30	1,94	9,80	2,51	12,80	3,85	20,00
1300	0,34	1,47	0,65	2,87	1,12	4,96	1,76	7,87	2,30	10,91	3,53	17,04
1400	0,29	1,18	0,56	2,30	0,96	3,97	1,52	6,30	2,13	9,40	3,26	14,69
1500	0,25	0,96	0,49	1,87	0,84	3,23	1,32	5,12	1,95	7,65	3,03	12,80
1600	0,22	0,79	0,43	1,54	0,74	2,66	1,16	4,22	1,71	6,30	2,83	11,25
1700	0,20	0,66	0,38	1,28	0,65	2,22	1,03	3,52	1,52	5,25	2,65	9,97
1800	0,18	0,55	0,34	1,08	0,58	1,87	0,91	2,96	1,35	4,42	2,49	8,64
1900	0,16	0,47	0,30	0,92	0,52	1,59	0,82	2,52	1,21	3,76	2,32	7,35
2000	0,14	0,40	0,27	0,79	0,47	1,36	0,74	2,16	1,09	3,23	2,10	6,30

*span (mm)	25 x 3		30 x 3		35 x 3		40 x 3		50 x 3		60 x 3	
	Fp	Fv	Fp	Fv	Fp	Fv	Fp	Fv	Fp	Fv	Fp	Fv
300	8,33	120,00	11,88	172,80	16,02	235,20	20,74	307,20	31,79	480,00	44,95	691,20
400	5,55	67,50	7,92	97,20	10,68	132,30	13,82	172,80	21,19	270,00	29,96	388,80
500	4,16	43,20	5,94	62,21	8,01	84,67	10,37	110,59	15,89	172,80	22,47	248,83
600	3,33	30,00	4,75	43,20	6,41	58,80	8,29	76,80	12,72	120,00	17,98	172,80
700	2,78	22,04	3,96	31,74	5,34	43,20	6,91	56,42	10,60	88,16	14,98	126,96
800	2,38	16,88	3,40	24,30	4,58	33,08	5,92	43,20	9,08	67,50	12,84	97,20
900	2,07	12,96	2,97	19,20	4,00	26,13	5,18	34,13	7,95	53,33	11,24	76,80
1000	1,67	9,45	2,64	15,55	3,56	21,17	4,61	27,65	7,06	43,20	9,99	62,21
1100	1,38	7,10	2,36	12,27	3,20	17,49	4,15	22,85	6,36	35,70	8,99	51,41
1200	1,15	5,47	1,98	9,45	2,91	14,70	3,77	19,20	5,78	30,00	8,17	43,20
1300	0,98	4,30	1,68	7,43	2,64	11,80	3,46	16,36	5,30	25,56	7,49	36,81
1400	0,84	3,44	1,45	5,95	2,27	9,45	3,19	14,11	4,89	22,04	6,91	31,74
1500	0,73	2,80	1,26	4,84	1,98	7,68	2,93	11,47	4,54	19,20	6,42	27,65
1600	0,65	2,31	1,11	3,99	1,74	6,33	2,57	9,45	4,24	16,88	5,99	24,30
1700	0,57	1,92	0,98	3,32	1,54	5,28	2,28	7,88	3,97	14,95	5,62	21,53
1800	0,51	1,62	0,87	2,80	1,37	4,45	2,03	6,64	3,74	12,96	5,29	19,20
1900	0,46	1,38	0,78	2,38	1,23	3,78	1,82	5,64	3,49	11,02	4,99	17,23
2000	0,41	1,18	0,71	2,04	1,11	3,24	1,64	4,84	3,14	9,45	4,73	15,55

Fp Single load kN

Fv Evenly distributed load kN/m²

 Non accessible area

 Accessible area

 Vehicle accessible up to 3 t.

 Vehicle accessible up to 9 t.

KICK-FLAT OPEN STEEL FLOOR

- Galvanised
- 150 x 5 x 6000mm (2201.GA)
- 150 x 6 x 6000mm (2202.GA)

FOR A FAST,
COMPETITIVE QUOTE
CALL NOW!



Kick Flat Plate
Product Ref:
2201.GA

FIXINGS OPEN STEEL FLOOR

- Secures Floor Grating
- Steel Manufacture
- 100 per box



Universal Clip
Product Ref:
2301



Internal Corner
Product Ref:
KCB1



External Corner
Product Ref:
KCB2



Kick Clamps
Product Ref:
K25 (25NB)
K40 (32 to 40NB)



Straight Connector
Product Ref:
KCB3

MORE THAN STEEL

STAIR TREADS OPEN STEEL FLOOR

- Our Stairtreads are fitted with drilled end plates for easy bolting to the supporting stringer
- Self colour or galvanised

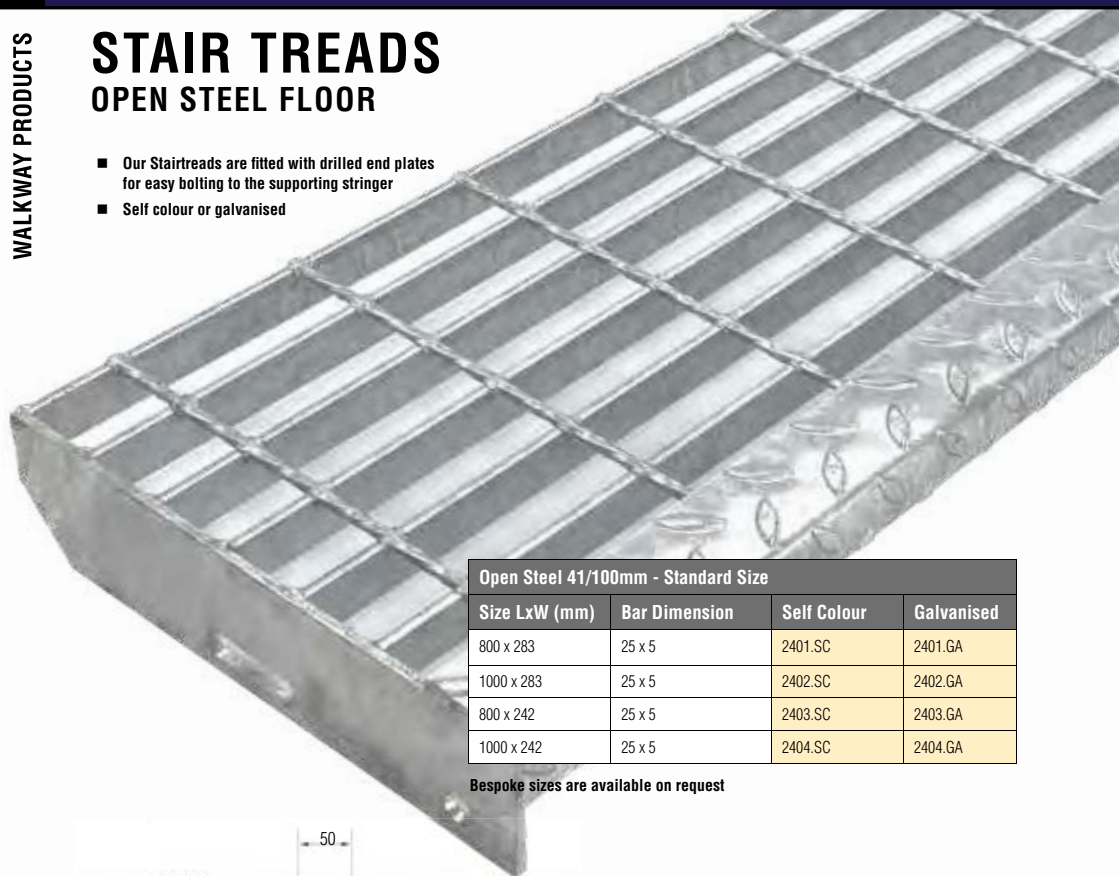

Open Steel 41/100mm - Standard Size

Size LxW (mm)	Bar Dimension	Self Colour	Galvanised
800 x 283	25 x 5	2401.SC	2401.GA
1000 x 283	25 x 5	2402.SC	2402.GA
800 x 242	25 x 5	2403.SC	2403.GA
1000 x 242	25 x 5	2404.SC	2404.GA

Bespoke sizes are available on request

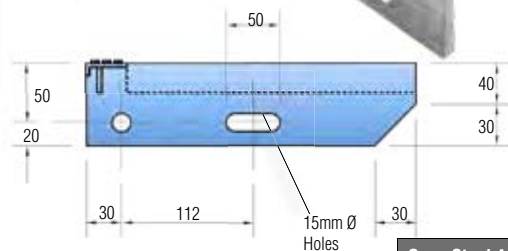

Open Steel 41/100mm - Open End (inc. 1 x end plate)

Size LxW (mm)	Bar Dimension	Self Colour	Galvanised
1000 x 283	25 x 5mm	2405.SC	N/A

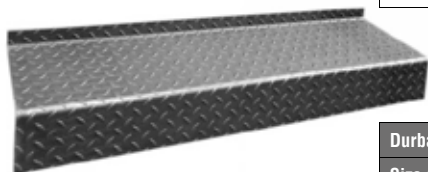

Durbar Stair Tread

Size (mm)	Up	Down	Self Colour	Galvanised
1000 x 265 x 4.5	40	40	2407.SC	N/A

PERFORATED PLANKS

- Profile planking for walkway, platforms and roofs
- Ideal for wet working places (37% permeable to air)
- Minimal maintenance and low installation cost
- Safe: ball with a 15mm calibre - ball can't fall through
- Slip-resistant surface, anti-slip class R12/13
- Split and embossed surface with serrated finish
- Available in galvanised steel and aluminium



STEPHUIT N

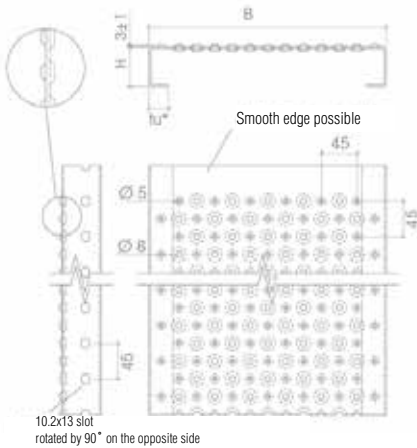

Ref.	Length	Depth	Width	Finish
2505.AL	3015 mm	50 mm	300 mm	Aluminium *
2506.SC	4005 mm	50 mm	240 mm	Self Colour †
2507.SC	4005 mm	50 mm	300 mm	Self Colour †

*3mm thickness, †2mm thickness

STEPBLOC F

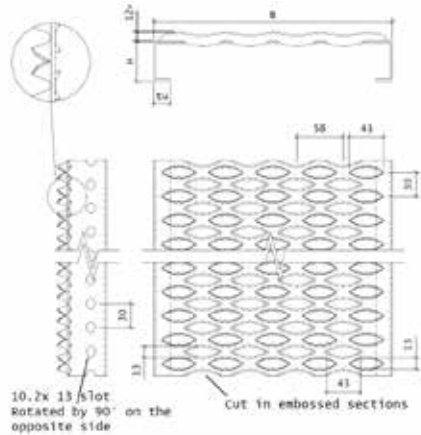

Ref.	Length	Depth	Width	Finish
2501.GA	4020 mm	50 mm	240 mm	Galvanised Δ
2502.GA	4020 mm	50 mm	300 mm	Galvanised Δ

Δ 2mm thickness



MORE THAN STEEL

FLOORPLATES TREADPLATE & NOSING

- Anti-slip: Helps to meet Health & Safety and DDA regulations
- Available in standard sizes or fabricated to size
- Also available as spiral treads and landing plates



Mild Steel Chequer Treadplates		
Dimensions	Dimension	Ref.
1000 x 265 x 4.5mm O/P	40mm	2407
1250 x 265 x 4.5mm O/P	40mm	2602
1250 x 265 x 6.0mm O/P	50mm	2603



Mild Steel Floor Plates		
Dimensions	Thickness (mm)	Weight (kg/m ²)
2000 x 1000	3.0	26.20
2000 x 1000	4.5	37.97
2000 x 1000	6.0	49.74
2000 x 1000	8.0	65.44
2000 x 1000	10.0	81.14
2000 x 1000	12.0	100.77
2500 x 1250	3.0	26.19
2500 x 1250	4.55	37.97
2500 x 1250	6.0	49.74
2500 x 1250	8.0	65.44
2500 x 1250	10.0	81.44
2500 x 1250	12.0	100.77
3000 x 1500	4.5	89.50
3000 x 1500	6.0	109.57
3000 x 1500	10.0	191.50

Octopus Nosing	
Dimensions	Ref.
5mm Thick x 3000mm long	2606
5mm Thick x 6000mm long	2607

Pyramid Nosing	
Dimensions	Ref.
30 x 5 x 1000mm long	2608
30 x 5 x 3000mm long	2609
30 x 5 x 6000mm long	2610

Chequer Plate Nosing	
Dimensions	Ref.
25 x 25 x 1000mm long	2611

TREADPLATE

ALUMINIUM & STAINLESS STEEL

- Wide range of construction and structural applications
- Non - Slip

ALUMINIUM TREADPLATES - 5 Bar, Tread 1.5mm

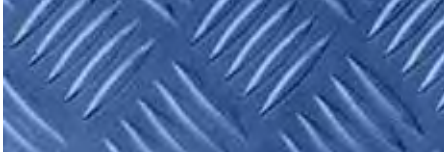

Grade 5754 H114

Length x Width	Thickness
2500mm x 1250mm	2.0 mm
2500mm x 1250mm	3.0 mm
2500mm x 1250mm	4.5 mm

ALUMINIUM TREADPLATES - 2 Bar, Tread 0.5mm



Grade 5754 H114

Length x Width	Thickness
2500mm x 1250mm	1.5 mm

ALUMINIUM TREADPLATES - 1 Bar, Tread 1.5mm



Grade 5754 H114

Length x Width	Thickness
3000mm x 1250mm	3.0 mm
2500mm x 1250mm	6.0 mm

STAINLESS TREADPLATES - 1 Bar, Tread 1.5mm



Grade 304

Length x Width	Thickness
3000mm x 1000mm	3.0 mm
2500mm x 1250mm	4.5 mm

We can supply made to size aluminium and stainless steel stairtreads.

ALUMINIUM & STAINLESS STEEL STAIRTREADS



**FOR A FAST,
COMPETITIVE QUOTE
CALL NOW!**

MORE THAN STEEL

GRP SAFEGRATING - M

- Moulded Square mesh
- No specific span direction
- Ex-stock: pre-gritted (concave available on demand)
- Fire-retardant
- Available in Grey, Green & Yellow
- Fabricated to size

Mesh Sizing

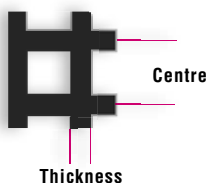

EX-STOCK



FIRE RETARDANT

Depth (mm)	Mesh Size (mm) Centre	Thickness (mm)	Panel Size (mm)	Open Area %	Approx Weight (kg/m ²)	Standard Surface	Standard Colours
14	19 x 19	7	3687 x 1247	42	16.0	Grit	Green / Grey / Yellow
22	19 x 19	7	2007 x 1507 3007 x 1007 4047 x 1247	42	20.5	Grit	Green / Grey
38	19 x 19	7	3050 x 1220	42	21.0	Grit	Green / Grey
25	38 x 38	7	1997 x 997 3012 x 997 3660 x 1220	70	13.5	Grit	Green / Grey / Yellow
30	38 x 38	7	3000 x 1000 4036 x 1000 3660 x 1220	70	15.5	Grit	Green
38	38 x 38	7	1997 x 997 3012 x 997 3660 x 1220	70	18.5	Grit	Green / Grey / Yellow
12	50 x 50	8	3660 x 1220	78	6.1	Grit	Grey
50	50 x 50	8	3660 x 1220	78	21.2	Grit	Green / Grey / Yellow



19 x 19mm Mini-Mesh

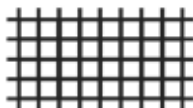

38 x 38 mm

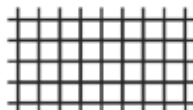

50 x 50mm

GRP CLIP

- 316 stainless steel
- Non load-bearing clips (help to stop lateral movement only)
- Set to include: top clip and bottom "J" clamp, 50mm long M8 bolt, nut and washer



GRP SAFETREADS

- Moulded Square grating
- Similar look to steel flooring
- For wide span applications
- (up to 1.5m based on 5 Kn/m² load factor)
- Gritted anti-slip top surface
- Available in Grey, Yellow & Green with Hi-Vis to suit

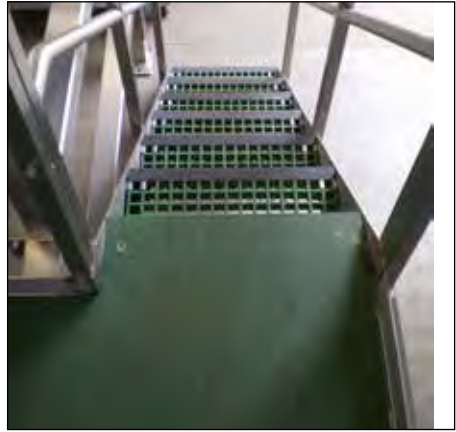

GRP SAFECOVERS

- Standard 3mm thick with a 55mm deep drop (available up to 60mm)
- Standard size – 1200mm x 300mm (other sizes on demand)
- Standard Colours – Grey, Yellow or Black (Complete with a Nosing colour to suit)
- Ideal for retrofit and provide good anti-slip surface
- DDA compliant



GRP SAFENOSE

- Gives added anti-slip factor to existing Stairs
- Available in two sizes: 55mm x 55mm & 55mm x 70mm
- 3000mm lengths
- Standard colours – Black, White, Yellow or Grey
- Easy fit – Screw or Glue
- DDA compliant



MORE THAN STEEL

EXPANDED METAL WALKWAY MESH

- Mild steel in self colour or galvanised (aluminium or stainless steel on demand)
- High strength-to-weight ratio (Tested and measured load bearing capacities)
- Anti-slip surface
- Economical solution for walkways, stairtreads and gantries
- Option to weld or join or clip the sheets in situ
- Standard sizes or Fabrication to size



4896



2496

Ref.	Aperture Dimension LW x SW (mm)	Strand Width (mm)	Strand Thickness (mm)	Overall Thickness (mm)	Weight (kg/m ²)	% Open Area	Stock Size
2496	60.96 x 25.40	6.1	4.5	12.7	17.29	51	2440 x 1200 1220 x 2440
4896	121.92 x 33.87	6.35	4.5	13.5	13.23	65	2440 x 1200

Other strand sizes are available on request

Raised Mesh Sizing Guide

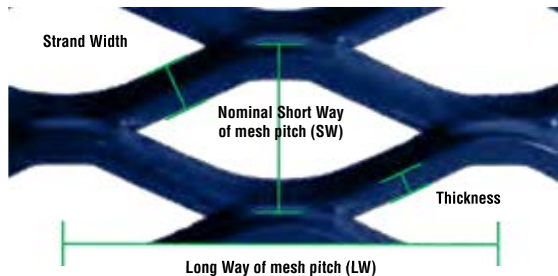

CRASH BARRIERS

CORRUGATED ARMCO

- Steel grade BSEN 10025 S275, 3mm thick
- Made from galvanised steel to BS729
- Available in PPC (Powder Coated)
- Recommended nominal post spacing: 3.2m
- Recommended height above floor level: 610mm
- Kit components: can be easily replaced

Ref: 2808.GA Barrier End Cap

Ref: 2801-13GA	ARMCO Beam 1.3M
Ref: 2801-1.9GA	ARMCO Beam 1.9M
Ref: 2801-3.5GA	ARMCO Beam 3.5M

Ref: 2805-560GA	Bolt-Down H Post 560mm
Ref: 2805-760GA	Bolt-Down H Post 760mm



MORE THAN STEEL

CRASH BARRIERS CORRUGATED ARMCO

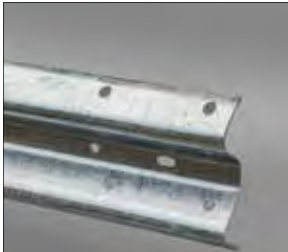

Ref:	Description
2801-13GA	ARMCO Beam 1.3M
2801-1.9GA	ARMCO Beam 1.9M
2801-3.5GA	ARMCO Beam 3.5M



Ref:	Description
2803-GA	90° Corner External



Ref:	Description
2804-GA	90° Corner Internal



Ref:	Description
2807-GA	Fishtale End



Ref:	Description
2816-GA	Pedestrian End



Ref:	Description
2819-GA	Flexible Corner Internal

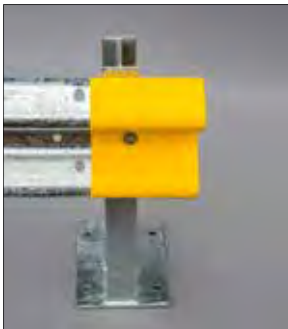

Ref:	Description
2808-GA	Beam End cap



Ref:	Description
2818-GA	Flexi Economy Corner

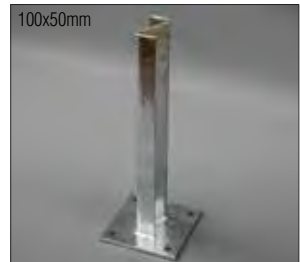

Ref:	Description
2814-560	Bolt-Down Z Post 560mm
2814-610	Bolt-Down Z Post 610mm
2814-760	Bolt-Down Z Post 760mm



Ref:	Description
2815-1200	Dig-In Z Post 1200mm
2815-1500	Dig-In Z Post 1250mm



Ref:	Description
2805-560GA	Bolt-Down H Post 560mm
2805-760GA	Bolt-Down H Post 760mm



Ref:	Description
2806-760GAHE	Bolt-Down H Post 760mm Handrail Extension



Ref:	Description
2813-1100DH	Bolt-Down H Post 1100mm Double Height



Ref:	Description
2805-1200GA	Dig-In H Post 1200mm
2805-1500GA	Dig-In H Post 1500mm
2805-1800GA	Dig-In H Post 1800mm



Ref:	Description
2823-POL	H Post Cap
2823-POL	Z Post Cap

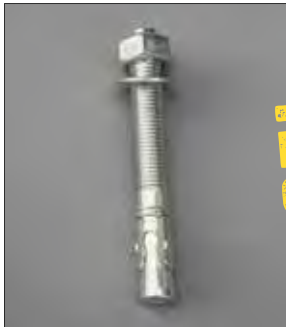

Ref:	Description
2827GA	Floor Anchor

**FOR A FAST,
COMPETITIVE QUOTE
CALL NOW!**

EASYDECK COMPOSITE DECKING

**NEW!
PRODUCT
LINE.**

SAFE & DURABLE COMPOSITE DECKING SYSTEM

EazyDeck anti-slip board range is perfect for balcony and terraced areas. The durable and lightweight board comes with a long warranty against warping, splitting and is virtually maintenance free ensuring piece of mind with each installation.

- 15 year residential, 10 year commercial limited warranty
- Non-slip surface
- Reversible finish (soft grain and grooved)
- Manufactured 90% recycled material
- Concealed safety securing clips and fastening system

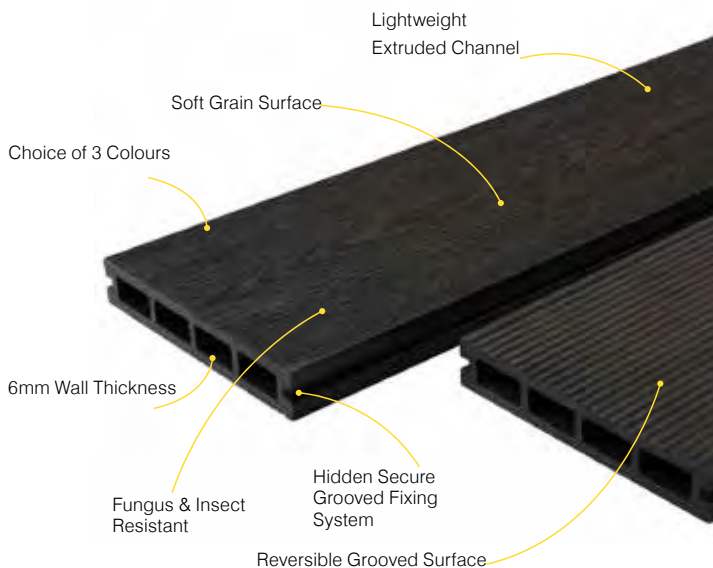

COMPOSITE DECKING

EAZYDECK
3.6M Length
147x23mm Profile

**FOR A FAST,
COMPETITIVE QUOTE
CALL NOW!**



Ref:	Description
2012336-CC	Charcoal 3.6M
2012336-GR	Grey 3.6M
2012336-TK	Teak 3.6M

EDGE BOARD
3.6M Length
72x11mm Profile

Ref:	Description
2021136-CC	Charcoal 3.6M
2021136-GR	Grey 3.6M
2021136-TK	Teak 3.6M

FIXING SCREWS



Ref:	Description
20330	Stainless Steel, Qty: 100

START FASTENER

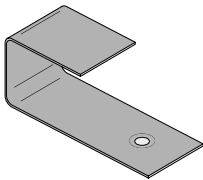

Ref:	Description
20310	Stainless Steel, Qty: 20

HIDDEN FASTENER

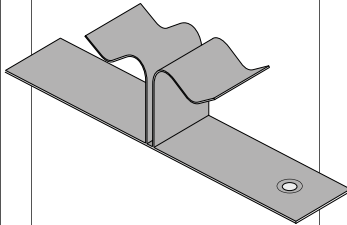

Ref:	Description
20320	Stainless Steel, Qty: 220

High strength
non-slip



Maintenance
free



Up to 15 year
warranty



Low water
absorption



Manufactured
using recycled
material



MESH + FENCING PRODUCTS

SECTION GUIDE

INDUSTRIAL WELDED MESH.....	77
PRISON MESH	78
STAINLESS STEEL MESH	79
EXPANDED METAL WALKWAY.....	80
EXPANDED METAL RAISED	82
& FLATTENED	
PERFORATED SHEETS	83
EDGING SECTIONS.....	85
PALISADE FENCING	86
PROFILED FENCING	89
TWIN AND PRISON MESH	
ULTRA MESH FENCING KITS	92
MESH GATES & ACCESS CONTROL	94
GATE KITS	95
BOW TOP RAILING	96

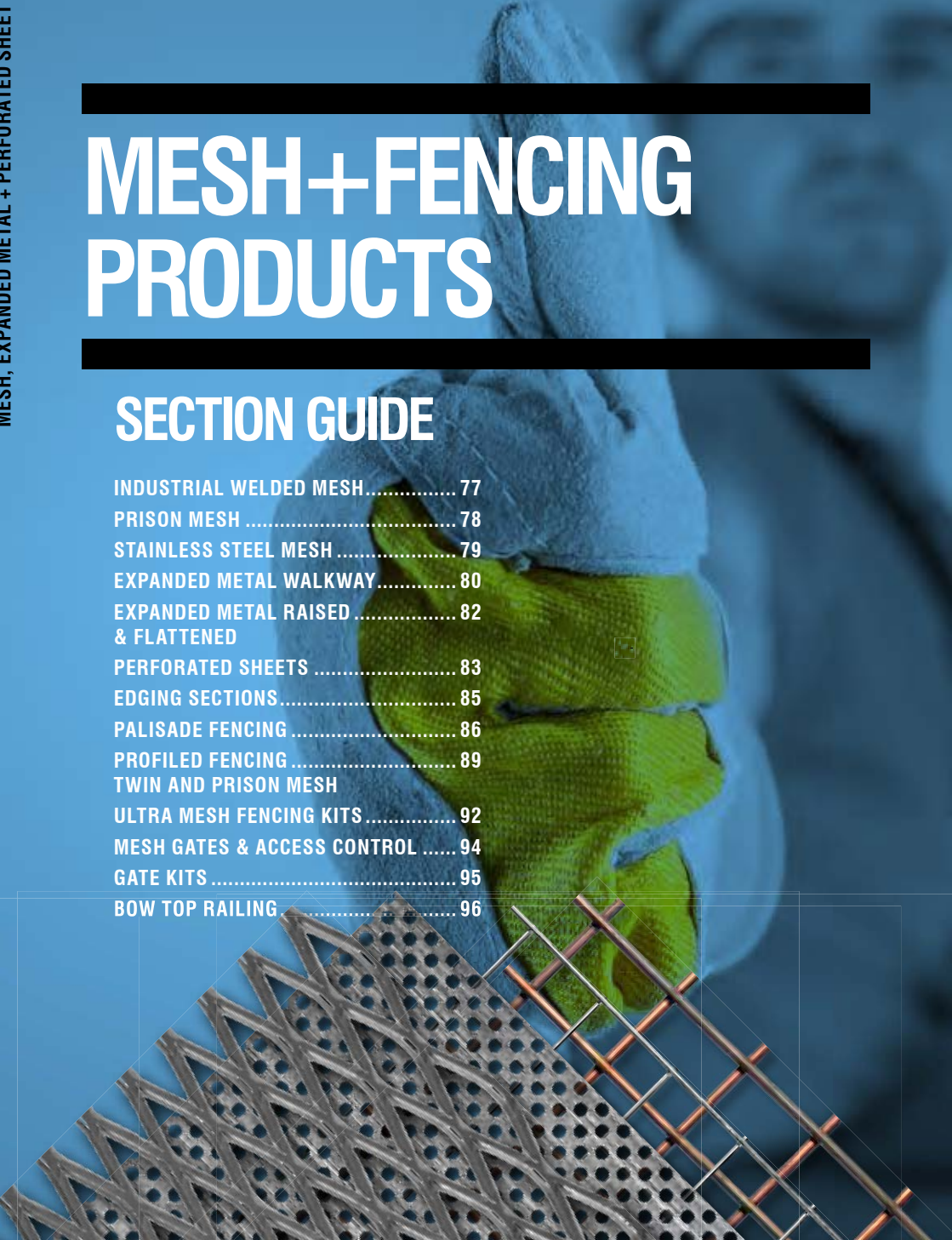

INDUSTRIAL WELDED MESH

Product Features

- Manufactured from copper washed direct drawn steel wire, conforming to BS 1052:1980
- Offered in a wide range of wire diameters from 2.0mm to 4.75mm
- Five standard panel sizes available
- Wide range of mesh configurations available
- Resistance welded at every intersection to give maximum strength
- Also offered as hot dip galvanised finish to BS EN ISO 1461:2009

Applications

- Window Guards
- Machinery Guards
- Cages and Lockers
- Shelving
- Racking
- Hayracks
- Pig Flooring
- Security Grill

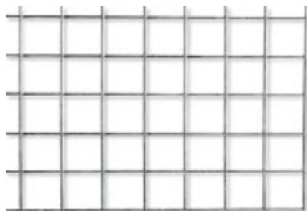

Hot Dip Galvanised Finish

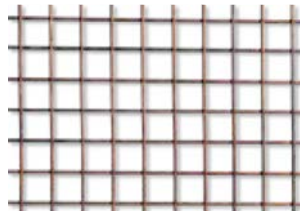

Copper Washed Finish

Mesh Aperture & Wire Gauge	Approximate Weight per panel in Kg					Metric (mm)
	4' X 8'	6' X 12'	6' X 4'	6' X 3'	7' X 12'	
3" x 6" x 6g	8.65	19.07	6.53	4.69	22.16	75 x 150 x 4.75
3" x 3" x 6g	10.75	23.83	8.57	6.14	27.72	75 x 75 x 4.75
2" x 2" x 6g	15.88	35.38	12.65	9.03	41.19	50 x 50 x 4.75
3" x 1/2" x 8g	25.23	-	-	-	-	75 x 13 x 3.90
3" x 3" x 8g	7.45	16.55	6.08	4.56	19.25	75 x 75 x 3.90
2" x 2" x 8g	11.00	24.57	8.30	6.27	28.61	50 x 50 x 3.90
2" x 1" x 8g	16.34	39.49	13.30	9.98	46.00	50 x 25 x 3.90
1" x 1" x 8g	21.67	50.90	17.08	12.86	59.33	25 x 25 x 3.90
4" x 4" x 10g	3.34	-	-	-	-	100 x 100 x 3.00
3" x 1/2" x 10g	14.85	33.26	11.15	8.39	38.77	75 x 13 x 3.00
3" x 3" x 10g	4.38	9.71	3.42	2.50	11.30	75 x 75 x 3.00
3" x 1" x 10g	8.57	19.13	6.66	5.02	22.29	75 x 25 x 3.00
2" x 2" x 10g	6.48	14.42	4.87	3.68	16.79	50 x 50 x 3.00
2" x 1" x 10g	9.62	21.49	7.48	5.63	25.04	50 x 25 x 3.00
1 1/2" x 1 1/2" x 10g	8.57	-	-	-	-	38 x 38 x 3.00
1" x 1" x 10g	12.76	28.55	6.58	7.21	33.28	25 x 25 x 3.00
3" x 1/2" x 12g	9.99	22.39	7.51	5.65	26.09	75 x 13 x 2.50
3" x 1" x 12g	5.77	12.88	4.55	3.41	15.73	75 x 25 x 2.50
2" x 2" x 12g	4.36	9.71	3.28	2.48	11.30	50 x 50 x 2.50
2" x 1" x 12g	6.47	14.46	5.11	3.83	17.67	50 x 25 x 2.50
1" x 1" x 12g	8.58	19.22	6.45	4.85	22.40	25 x 25 x 2.50
1" x 1" x 14g	5.75	-	-	-	-	25 x 25 x 2.50

PRISON MESH

358 PRE-GALVANISED PRISON MESH

Product Features

- Material: Pre-galvanised or Galfan
- Applications: Home Office buildings (High-profile prisons, secure hospitals, etc)

- Key features: finger-proof, anti-climb and cutter-resistant
- Excellent through-visibility
- Available in 3658mm wide and 6096mm high
- 3" and 0.5" mesh apertures panels are provided in 44mm wire (bespoke design on application)

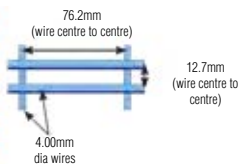
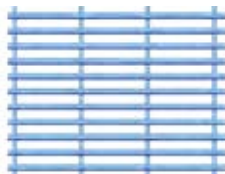

Panel Finishes Available

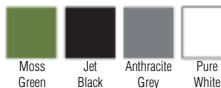

A wide range of additional colours are available, please contact our sales team for further details.



Standard Panel Specifications

Panel Dimension wire centre to centre (mm)	Mesh Config. wire centre to centre (mm)	Wire diameter prior to welding (mm)	Approx. Panel Weight (kg)	Pallet Quantities	Galvanised Wire Panels Stock Sizes
2515 x 1207	76.2 x 12.7	3.85mm	27.2	50	✓
2515 x 1270	76.2 x 12.7	3.85mm	28.6	50	✓
2515 x 1829	76.2 x 12.7	3.85mm	41.1	25	✓
2515 x 2007	76.2 x 12.7	3.85mm	45.0	25	
2515 x 2134	76.2 x 12.7	3.85mm	47.8	25	✓
2515 x 2438	76.2 x 12.7	3.85mm	54.6	25	✓
2515 x 2705	76.2 x 12.7	3.85mm	60.6	25	✓
2515 x 2997	76.2 x 12.7	3.85mm	67.1	20	✓
2515 x 3302	76.2 x 12.7	3.85mm	73.9	20	
2515 x 4204	76.2 x 12.7	3.85mm	94.0	15	
2515 x 5207	76.2 x 12.7	3.85mm	116.4	10	

MESH CLIPS



Code

30201



Code

30202

For securely fixing mesh

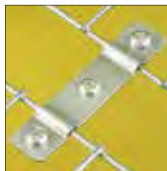

Code

30203

For securely fixing mesh



Code

30204

For securely fixing mesh



Spec

Double

171B

Double

171C

Single

170B

Single

170C

Mesh panel clip

STAINLESS EXPANDED MESH

- Grade 304 (other grades 316, 304S17 & 321S31 on demand)
- Ideal for applications involving high temperature
- Mesh orientation: Long way or Short way (see below)
- Standard sizes or Fabrication to size

Raised Stainless Expanded Mesh

Ref No.	LWD	SWD	Strand Width	Strand Thickness	Kg/m	% Open Area	Stock Size	Standard Size
926S	3.18	1.95	0.79	0.46	2.95	19	510 x 1070	
707S	4.75	2.39	0.56	0.46	1.71	53	1250 x 1250	
227S	5.84	3.39	0.61	0.46	1.74	52	1250 x 1250	
228S	5.84	3.39	1.22	0.50	2.65	26	1250 x 1250	
196S	14.29	5.54	1.33	0.90	3.46	52	1250 x 1250	
197S	14.29	5.54	1.33	0.70	2.69	52		1250 x 1250
198S	14.29	5.54	1.01	0.50	1.42	84		1250 x 1250
0796S	19.05	7.26	1.71	0.70	2.65	53		2500 x 1250
0790S	19.05	7.26	1.71	0.90	3.41	53	2500 x 1250	
1192S	28.59	9.53	2.24	1.50	5.58	53		2500 x 1250
1195S	28.59	9.53	2.24	1.20	4.52	53		2500 x 1130
1197S	28.59	9.53	2.24	0.90	3.39	53		2500 x 1250
1288S	30.48	11.72	1.83	1.50	3.70	69		2500 x 1250
1289S	30.48	11.72	1.83	1.20	3.01	69		2500 x 1250
1290S	30.48	11.72	1.83	0.90	2.25	69		2500 x 1250
1295S	30.48	11.72	2.06	1.50	4.17	85		2500 x 1130
1297S	30.48	11.72	2.06	1.20	3.36	65		2500 x 1130
1590S	38.10	16.48	1.91	1.50	2.75	77	2500 x 1250	
1591S	38.10	16.48	1.91	1.20	2.23	77		2500 x 1250
1592S	38.10	16.48	1.91	0.90	1.67	77		2500 x 1250
2083S	60.80	21.77	2.54	1.50	2.77	77		2500 x 1250
2087S	50.80	21.77	2.54	1.20	2.24	77		2500 x 1250
3088S	76.20	33.87	3.00	1.50	3.10	82		2500 x 1120

Flattened Stainless Expanded Mesh

Ref No.	LWD	SWD	Strand Width	Strand Thickness	Kg/m	% Open Area	Stock Size	Standard Size	
228SF	3.00	1.00	1.22	0.50	0.50	2.84	26	1250 x 1250	
197SF	10.50	3.90	1.33	0.70	0.70	2.69	57	1250 x 1250	
198SF	10.50	3.90	1.01	0.50	0.90	1.42	83		1250 x 1250
0793SF	14.22	4.63	1.80	0.69	0.70	2.40	56		1250 x 1250
0794SF	14.22	4.59	1.83	0.95	0.90	3.01	56	1250 x 1250	
1189SF	23.00	4.45	2.54	1.37	1.50	5.35	47		2900 x 1250
1190SF	23.50	4.65	2.44	1.09	1.20	4.40	48		2500 x 1250
1191SF	23.50	5.05	2.24	0.99	0.90	3.30	53		2500 x 1250
1276SF	29.00	8.00	1.98	1.09	1.20	2.93	67	2500 x 1250	
1277SF	24.38	7.96	1.88	0.96	0.90	2.20	68		2500 x 1250
1281SF	24.38	7.87	2.39	1.37	1.50	4.06	62		2500 x 1130
1282SF	24.38	7.82	2.24	1.09	1.20	3.30	63		2900 x 1130
1582SF	33.53	12.96	2.06	1.09	1.20	2.15	75		2500 x 1250
1583SF	35.05	12.56	1.96	0.95	0.90	1.62	76	2500 x 1250	
2083SF	42.00	16.34	2.72	1.09	1.20	2.16	75		2600 x 1280
2089SF	41.00	15.98	2.90	1.37	1.50	2.66	73		2500 x 1250
3079SF	66.83	27.00	3.43	1.37	1.50	2.02	80		2500 x 1120



Raised Mesh 0798S



Flat Mesh 1276SF



Raised Mesh 1590S

EXPANDED METAL WALKWAY MESH

- Mild steel in self colour or galvanised (aluminium or stainless steel on demand)
- High strength-to-weight ratio (Tested and measured load bearing capacities)
- Anti-slip surface
- Economical solution for walkways, stairtreads and gantries
- Option to weld or join or clip the sheets in place
- Standard sizes or Fabrication to size

- ✓ HIGH STRENGTH
- ✓ ANTI SLIP
- ✓ LOW COST



4896



2496

Ref.	Aperture Dimension LW x SW (mm)	Strand Width (mm)	Strand Thickness (mm)	Overall Thickness (mm)	Weight (kg/m ²)	% Open Area	Stock Size
2496	60.96 x 25.40	6.1	4.5	12.7	17.29	51	2440 x 1200 1220 x 2440
4896	121.92 x 33.87	6.35	4.5	13.5	13.23	65	2440 x 1200

Other strand sizes are available on request

Raised Mesh Sizing Guide

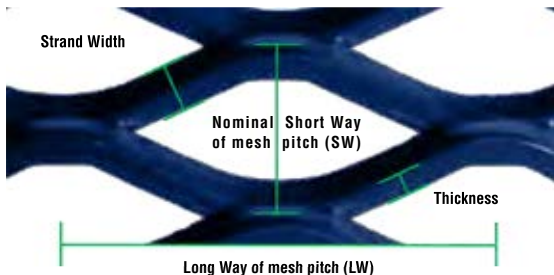

EXPANDED METAL RAISED & FLATTENED MESHES

- Mild steel or galvanised (aluminium or stainless steel on demand)
- Raised or flattened
- Mesh orientation: Long way or Short way (see below)
- Standard sizes or Fabrication to size

RAISED MESHES

Ref No.	LWD	SWD	Strand Width	Strand Thickness	Kg/m	% Open Area	Stock Size	Standard Size
220	5.84	3.50	0.79	0.60	2.11	55	1250 x 1250	
221	5.84	3.39	1.17	0.60	3.25	31		1250 x 1250
223	5.84	3.50	1.58	0.60	4.23	10		1250 x 1250
203	10.24	5.64	0.79	0.60	1.31	72	1250 x 1250	
204	10.24	5.64	1.17	0.60	1.95	59		1250 x 1250
205	10.24	5.64	1.55	0.60	2.58	45		1250 x 1250
206	10.24	5.64	1.17	0.75	2.44	59		1250 x 1250
207	10.24	5.64	1.55	0.75	3.23	45		1250 x 1250
208	10.24	5.64	1.17	1.00	3.25	59		1250 x 1250
209	10.24	5.64	1.55	1.00	4.30	45	1250 x 1250	
210	10.24	5.64	1.17	1.20	3.90	59		1250 x 1250
215	10.24	4.76	1.52	1.00	5.02	36		1250 x 1250
199	14.29	5.64	1.17	1.00	3.25	59	1250 x 1250	
0798	19.05	7.43	1.70	1.00	3.59	54	2500 x 1250	
1194	28.58	9.52	1.98	1.20	3.92	58	2440 x 1220	
1199	28.58	9.52	1.65	1.00	2.72	65		2440 x 1220
1292	30.48	13.86	4.75	2.50	14.87	25	1220 x 1525	
1294	30.48	11.72	2.36	1.60	5.06	60	2440 x 1220	
1295	30.48	11.72	1.98	1.80	4.24	56	2440 x 1220	
1296	30.48	11.72	2.36	1.20	3.79	60	2440 x 1220	
1297	30.48	11.72	2.96	1.20	3.30	56		2440 x 1220
1298	30.48	11.72	1.63	1.00	2.17	72		2440 x 1220
1299	30.48	11.72	1.19	1.20	1.92	80	2440 x 1220	
1574	38.10	16.93	4.75	3.00	13.20	44	2440 x 1220	
1595	38.10	16.93	3.08	1.60	4.57	54	2440 x 1220	
1597	38.10	16.45	2.25	1.60	3.43	73	2440 x 1220	
1598	38.10	16.93	2.31	1.20	2.67	73	2440 x 1220	
2088	50.80	22.58	3.89	3.00	8.09	66	2440 x 1220	
2089	50.80	22.58	3.12	3.00	6.62	72	2440 x 1220 1220 x 2440	
2091	50.80	22.58	2.52	2.50	4.37	78	1220 x 2440	
2093	50.80	22.58	3.05	1.60	3.29	73	2440 x 1220	
2094	50.80	22.58	2.24	1.60	2.49	80		2440 x 1220
2096	50.80	22.58	2.34	1.20	1.95	79	1220 x 2440	
2097	50.80	22.58	1.60	1.80	1.76	86		2440 x 1220
2499	60.96	24.36	2.16	1.60	2.22	82		2440 x 1220
3092	76.20	33.87	3.58	3.00	4.97	79	2440 x 1220	
3093	76.20	33.87	2.92	2.50	3.37	83		2440 x 1220
3094	76.20	33.87	3.89	3.00	5.39	77		2440 x 1220
3098	76.20	33.87	2.72	1.60	2.02	84		2440 x 1220
3396	85.73	40.64	3.18	3.00	3.67	84	2440 x 1220	
3398	85.73	39.33	2.59	2.50	2.99	87		2440 x 1220
4095	101.60	45.65	4.30	3.00	4.46	81		2440 x 1220
4097	101.60	50.80	3.35	3.00	3.11	87	2440 x 1220	
4594	114.30	38.33	3.07	3.00	3.67	84		2440 x 1220
4595	114.30	40.64	3.47	4.50	16.45	53		2440 x 1220
4596	114.30	40.64	7.90	4.50	13.70	61		2440 x 1220
4597	114.30	40.64	5.92	4.50	10.28	71		2440 x 1220
4598	114.30	40.64	6.32	3.00	7.32	69		2440 x 1220
4599	114.30	39.33	4.80	3.00	6.48	77	2440 x 1220	

EXPANDED METAL RAISED & FLATTENED MESHES

- Mild steel or galvanised (aluminium or stainless steel on demand)
- Raised or flattened
- Mesh orientation: Long way or Short way (see below)
- Standard sizes or Fabrication to size

FLATTENED MESHES

Ref No.	LWD	SWD	Strand Width	Strand Thickness		Kg/m	% Open Area	Stock Size	Standard Size
				Before Flattening	After Flattening				
708F	2.79	0.81	0.76	0.56	0.60	3.01	35	1250 x 1250	
226F	3.81	2.03	0.79	0.58	0.60	2.11	56	1250 x 1250	
217F	6.83	3.56	1.30	0.94	1.00	3.00	58	1250 x 2500	
0794F	14.22	4.83	1.85	0.96	1.00	3.30	57	1250 x 2500	
1279F	23.11	5.84	3.20	1.52	1.60	6.27	48	2440 x 1220	
1280F	24.38	7.11	2.39	1.14	1.20	3.84	60	2440 x 1220	
1281F	24.38	7.87	2.06	1.47	1.60	4.37	86	2440 x 1220	
1282F	24.38	7.62	2.08	1.14	1.20	3.17	65	2440 x 1220	
1283F	23.18	8.64	1.65	0.94	1.00	2.06	72		2440 x 1220
1284F	24.38	9.40	1.22	1.14	1.20	1.87	79		2440 x 1220
1584F	32.77	10.92	3.18	1.50	1.60	4.41	53	2440 x 1220	
1585F	33.53	12.45	2.34	1.14	1.20	2.47	73	2440 x 1220	
2073F	42.93	14.22	4.60	2.69	3.00	8.59	61	2440 x 1220	
2074F	39.12	18.29	4.72	2.74	3.00	7.55	66	1220 x 2440	
2076F	43.43	18.03	2.31	1.14	1.20	1.85	80	2440x1220 1220x2440	
2077F	43.18	17.27	3.23	1.45	1.60	3.24	73	2440 x 1220	
2079F	43.94	18.80	2.36	1.45	1.60	2.38	60		2440 x 1220
2080F	42.93	20.32	1.73	1.45	1.60	1.74	85		2440 x 1220
2490F	45.00	17.00	6.00	3.70	4.00	13.18	54	1220 x 2440	
2493F	52.07	20.22	2.29	1.45	1.60	2.13	62		2440 x 1220
3064F	65.83	28.70	2.83	1.45	1.60	1.88	94		2440 x 1220
3065F	66.59	30.23	2.03	1.45	1.60	1.35	69		2440 x 1220
3383F	77.47	37.18	6.53	2.82	3.00	7.15	68	2445 x 1220	
3384F	69.84	37.08	5.49	2.16	2.80	3.97	77	1220 x 2440	
3385F	76.96	32.77	3.61	1.85	2.00	2.80	61	2440 x 1220	



Flat Mesh 2073



Flat Mesh 2074



Raised Mesh 203



Raised Mesh 1196 / 1199



Raised Mesh 2089

PERFORATED SHEET

- Hole shapes: Round, Square or Slotted (others on demand)
- Hole size from 0.5mm to 40mm
- Pitch: Diagonal or square
- Material: Mild steel (self-colour or galvanised), Stainless Steel (304 or 316) or Aluminium
- With margins or unperforated area
- Material thickness from 0.3mm to 10mm
- Standard sheets: 2x1m or 2.5m or 1.25m

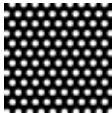

Flyscreen, Mild Steel (Galvanised) Product Reference:	Hole (mm)	Pitch (mm)	% Open Area	Thickness (mm)	Stock Size (mm)
 3410	2.2	3	47	0.35	2438 x 915

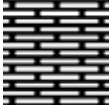
Square hole, Mild Steel (Self Colour) Product Reference:	Hole (mm)	Pitch (mm)	% Open Area	Thickness (mm)	Stock Size (mm)	
	3421	6	9	44	1	2000 x 1000
	3422	6	9	44	1.5	2000 x 1000
	3423	6	9	44	2	2000 x 1000
	3424	10	15	44	1	2000 x 1000
	3425	10	15	44	1.5	2000 x 1000
	3426	10	15	44	2	2000 x 1000
	3427	10	15	44	3	2000 x 1000

Slotted hole, Mild Steel (Self Colour) Product Reference:	Hole (mm)	% Open Area	Thickness (mm)	Stock Size (mm)	
 3431	2 x 20	2	2	2000 x 1000	
	3432	15 x 20	44	1	2000 x 1000
	3433	15 x 20	44	1.5	2000 x 1000
	3434	15 x 20	44	2	2000 x 1000

Bespoke sizes available on request

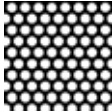
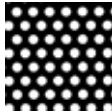
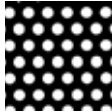
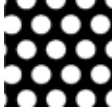
Also available in other materials such as Mild steel Galvanised, Stainless Steel (304 or 316), Aluminium.







Round hole, Diagonal Pitch Mild Steel (Self Colour) Product Reference:	Hole (mm)	Pitch (mm)	% Open Area	Thickness (mm)	Stock Size (mm)	
	3442 3443	3	4	51	1	2000 x 1000 2500 x 1250
	3444	3	4	51	1.5	2000 x 1000
	3445	3	4	51	2	2000 x 1000
	3446 3447 3448	3	5	32	1	2000 x 1000 2500 x 1250 3000 x 1500
	3449 3450 3451	3	5	32	1.5	2000 x 1000 2500 x 1250 3000 x 1500
	3452 3453 3454	3	5	32	2	2000 x 1000 2500 x 1250 3000 x 1500
	3455 3456 3457	3	5	32	3	2000 x 1000 2500 x 1250 3000 x 1500
	3483	5	7	46	1.5	2500 x 1250
	3458 3459 3460	6	9	40	1	2000 x 1000 2500 x 1250 3000 x 1500
	3461 3462 3463	6	9	40	1.5	2000 x 1000 2500 x 1250 3000 x 1500
	3464 3465 3466	6	9	40	2	2000 x 1000 2500 x 1250 3000 x 1500
	3467 3468 3469	6	9	40	3	2000 x 1000 2500 x 1250 3000 x 1500
	3470 3471 3472	6	9	40	6	2000 x 1000 2500 x 1250 3000 x 1500
	3473 3474	12	16	51	1.5	2000 x 1000 2500 x 1250
	3475 3476	12	16	51	2	2000 x 1000 2500 x 1250
	3477 3478	12	16	51	3	2000 x 1000 2500 x 1250
	3479 3480	12	16	51	4	2000 x 1000 2500 x 1250
	3481 3482	12	16	51	10	2000 x 1000 2500 x 1250

Bespoke sizes available on request

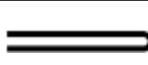
Also available in other materials such as Mild steel Galvanised, Stainless Steel (304 or 316) , Aluminium.

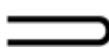
EDGING SECTIONS

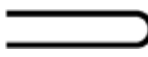
- Economical and functional solution to make a mesh sheet into a panel
- Available in mild steel
- Suitable for both flattened and raised mesh

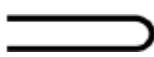
Product Reference:	Width (mm)	Thickness (mm)	Gap (mm)	Weight (Kg/m)	Std.Length (mm)	
For framing flattened expanded metal up to and including 1.58mm thick.						
	U3	12.7	0.9	1.78	0.18	2540
	U4	19.05	1.2	1.78	0.38	3810
For framing flattened expanded metal up to and including 3.18mm thick.						
	U6	12.7	0.9	3.3	0.2	2540
	U7	19.05	1.2	3.3	0.38	3810
	U8	31.75	1.2	3.3	0.62	3810
For framing conventional expanded metal up to and including 2.39mm thick.						
	U9	19.05	1.2	5.08	0.38	3810
	U10	31.75	1.2	5.08	0.62	3810
For framing conventional expanded metal up to and including 4.75mm thick.						
	U14	38.1	1.5	10.16	0.91	3810
For framing conventional expanded metal up to and including 2.39mm thick.						
	U18	19.05	1.2	6.5	0.42	3810
	U19	31.75	1.2	6.5	0.66	3810

SECURE FENCE PALISADE FENCING KITS

1.8, 2.1 & 2.4m
HEIGHT OPTIONS

ROUND, NOTCHED,
SINGLE POINT & TRIPLE
POINT AVAILABLE

FOR A FAST,
COMPETITIVE QUOTE
CALL NOW!

PALISADE FENCING 1.8M

31101HR BAY

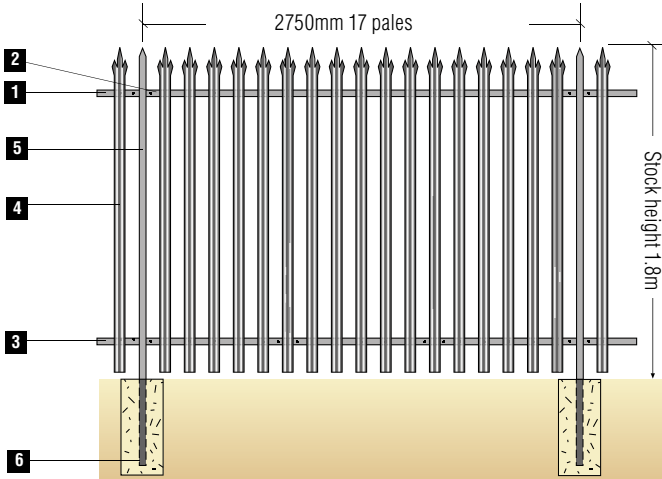

Key

1. Fish plate to which Top and Bottom Rail are fixed using M12 anti-vandal fixings.
2. Top Rail - SecureRail to which pales are fixed using SecureBolt or SecureRivet.
3. Bottom Rail - SecureRail to which pales are bolted using SecureBolt or SecureRivet.
4. Fencing Pale: SecurePale.
5. Standard SecurePost.
6. Concrete foundation.

Illustration shown as Galvanised finish (BS EN ISO 1461)

Ref	Part	Qty.	Description
31101HR	Pales	17	2mm "W" section. 2.35m long with triple point tops*
	Post	1	100 x 55 x 6.72mm 2400mm o/a, including loose fishplates (without baseplates)
	Horizontal	2	50 x 50 x 6mm RSA, 2750mm o/a
	Bolts	2	M12 square bolts with Permacone Nuts
	8mm Bolts	34	Galvanised Saddle Head Bolts with Permacone Nuts
	Fish Plates	2	-

*Other tops and RAL colours are available on demand are available on demand.



ROUND & NOTCHED



TRIPLE POINTED



SINGLE POINT



ROUND TOP

Paling Heads

We supply a selection of heads that can be used with our fencing systems and care should be taken to select the correct head to suit the requirement needed for your project.

PALISADE FENCING 2.1M

31102HR - BAY

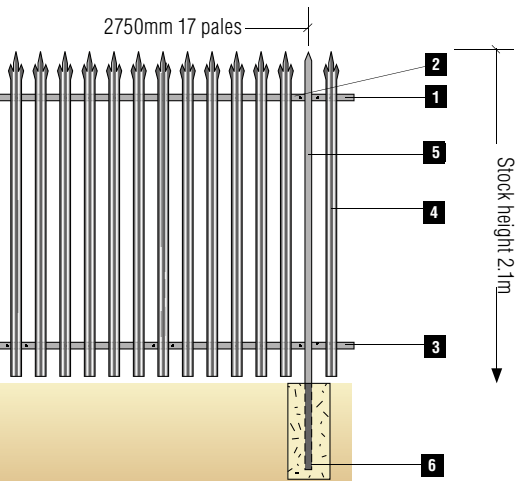

Illustration shown as Galvanised finish (BS EN ISO 1461)

Key

1. Fish plate to which Top and Bottom Rail are fixed using M12 anti-vandal fixings.

2. Top Rail - SecureRail to which pales are fixed using SecureBolt or SecureRivet.

3. Bottom Rail - SecureRail to which pales are bolted using SecureBolt or SecureRivet.

4. Fencing Pale: SecurePale.

5. Standard SecurePost.

6. Concrete foundation.

Ref	Part	Qty.	Description
31102HR	Pales	17	2mm 'D' section. 1.75m long with triple point tops*
	Post	1	100 x 55 x 6.72mm 2325mm o/a, including loose fishplates (without baseplates)
	Horizontal	2	50 x 50 x 6 RSA, 2750mm o/a
	Bolts	2	M12 square bolts with Permacone Nuts
	8mm Bolts	34	Galvanised Saddle Head Bolts with Permacone Nuts
	Fish Plates	2	-

*Other tops and RAL colours are available on demand are available on demand.

PALISADE FENCING 2.4M

31103HR - BAY

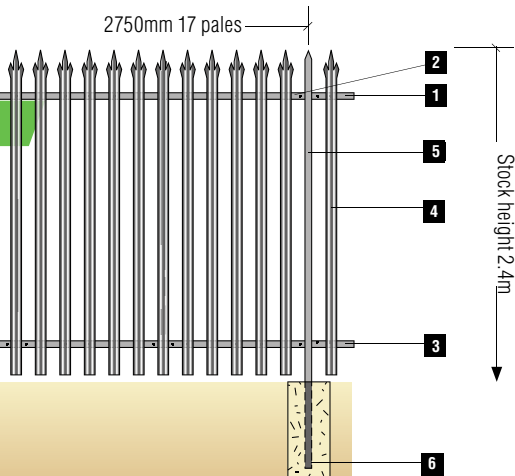

Illustration shown as Galvanised finish (BS EN ISO 1461)

Ref	Part	Qty.	Description
31103HR	Pales	17	2mm 'D' section. 1.75m long with triple point tops*
	Post	1	100 x 55 x 6.72mm 2325mm o/a, including loose fishplates (without baseplates)
	Horizontal	2	50 x 50 x 6 RSA, 2750mm o/a
	Bolts	2	M12 square bolts with Permacone Nuts
	8mm Bolts	34	Galvanised Saddle Head Bolts with Permacone Nuts
	Fish Plates	2	-

*Other tops and RAL colours are available on demand are available on demand.

ADDITIONAL COMPONENTS

Ref	Part	Description
31104HR	HR Post	3125mm o/a including loose fishplates (without baseplates)
31105HR	M12 bolts	Square bolts with Permacone Nuts
31106HR	8mm bolts	Galvanised Saddle Head Bolts with Permacone Nuts

PROFILED FENCING, PRISON MESH & ULTRA MESH FENCING SYSTEMS

FOR A FAST,
COMPETITIVE QUOTE
CALL NOW!

MORE THAN STEEL

PROFILED FENCING

TWIN 656

- Rigid panel due to double 6mm diam. horizontal wires
- 22mm spike on top edge of panel to deter climbing (panel can be inverted if spikes are not required)
- Galvanised wire to BS EN 10244-2:2001 class D (triple coat anti-corrosion architectural finish available; min. quantities apply)
- Available in Standard RAL 6005-Moss Green & 9005-Jet Black
- Elegant and simple design
- Suitable for multi-lift installation

Fence Height Inc Spike (mm)	Panel Width (mm)	Horizontal Wire Dimension (mm)	Vertical Wire Dimension (mm)	Panel Weight (kg)
1830	2510	5.50 +/- 0.06	4.50 +/- 0.05	21.1
2030	2510	5.50 +/- 0.06	4.50 +/- 0.05	23.3
2430	2510	5.50 +/- 0.06	4.50 +/- 0.05	27.7

Applications

- Sport pitches
- Commercial sites
- Transport: Railway stations and airports
- Education: Creches, Schools and Colleges
- Residential areas

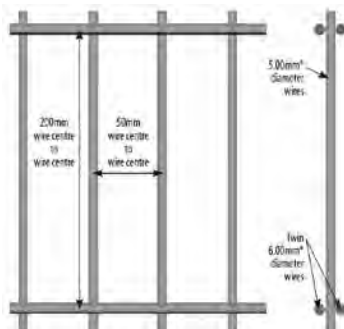

RAL available from stock

TWIN 868

- Robust, rigid panel due to double 8mm diam. horizontal wires
- 22mm spike on top edge of panel to deter climbing (panel can be inverted if spikes are not required)
- Galvanised wire to BS EN 10244-2:2001 class D (triple coat anti-corrosion architectural finish available; min. quantities apply)
- Available in Standard RAL 6005-Moss Green & 9005-Jet Black
- Elegant and simple design
- Suitable for multi-lift installation

Fence Height Inc Spike (mm)	Panel Width (mm)	H Wire Diameter (mm)	V Wire Diameter (mm)	Panel Weight (kg)
1830	2510	7.5	5.5	34.9
2030	2510	7.5	5.5	38.6
2430	2510	7.5	5.5	45.9

Applications

- Sport pitches
- Commercial sites
- Transport: Railway stations and airports
- Education: Creches, Schools and Colleges
- Residential areas

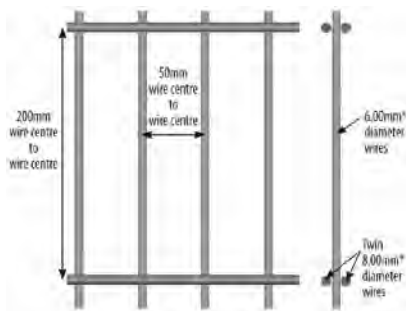

RAL available from stock

PRISON MESH

358 PRE-GALVANISED PRISON MESH

Product Features

- Material: Pre-galvanised or Galfan
- Applications: Home Office buildings (High-profile prisons, secure hospitals, etc)
- Key features: finger-proof, anti-climb and cutter-resistant
- Excellent through-visibility
- Available in 3658mm wide and 6096mm high
- 3" and 0.5" mesh apertures panels are provided in 44mm wire (bespoke design on application)
- Panel width 2515mm

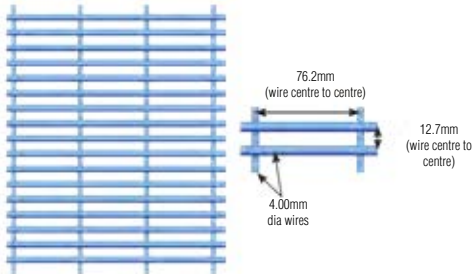

Panel Finishes Available

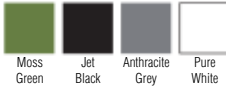

A wide range of additional colours are available, please contact our sales team for further details.

Standard Panel Specifications

Mesh Config. wire centre to centre (mm)	Wire diameter prior to welding (mm)	Approx. Panel Weight (kg)	Height	Galvanised Wire Panels Stock Sizes
76.2 x 12.7	3.85mm	41.1	1829	✓
76.2 x 12.7	3.85mm	45.0	2007	✓
76.2 x 12.7	3.85mm	47.8	2134	✓
76.2 x 12.7	3.85mm	54.6	2438	✓
76.2 x 12.7	3.85mm	60.6	2705	✓
76.2 x 12.7	3.85mm	67.1	2997	✓
76.2 x 12.7	3.85mm	73.9	3302	✓
76.2 x 12.7	3.85mm	94.0	4204	

MORE THAN STEEL

ULTRA MESH FENCING SYSTEM

Each kit comes supplied with the following:

- 3m Fence panel (1.8, 2.0 or 2.4m high);
- 'In-line' post - 1 post per kit
- Easy-fixing security clips and bolts
- End cap

Features

- 60x60 RHS Post
- 3m post centres
- 5mm wires
- Galvanised and powder coated
- Supplied in RAL 6005 Green

Applications

Our fencing kits are ideal for many purposes below are some of the more popular uses.

- Commercial sites
- Transport: Ports, station and airport
- Education: Schools and Colleges
- Residential areas

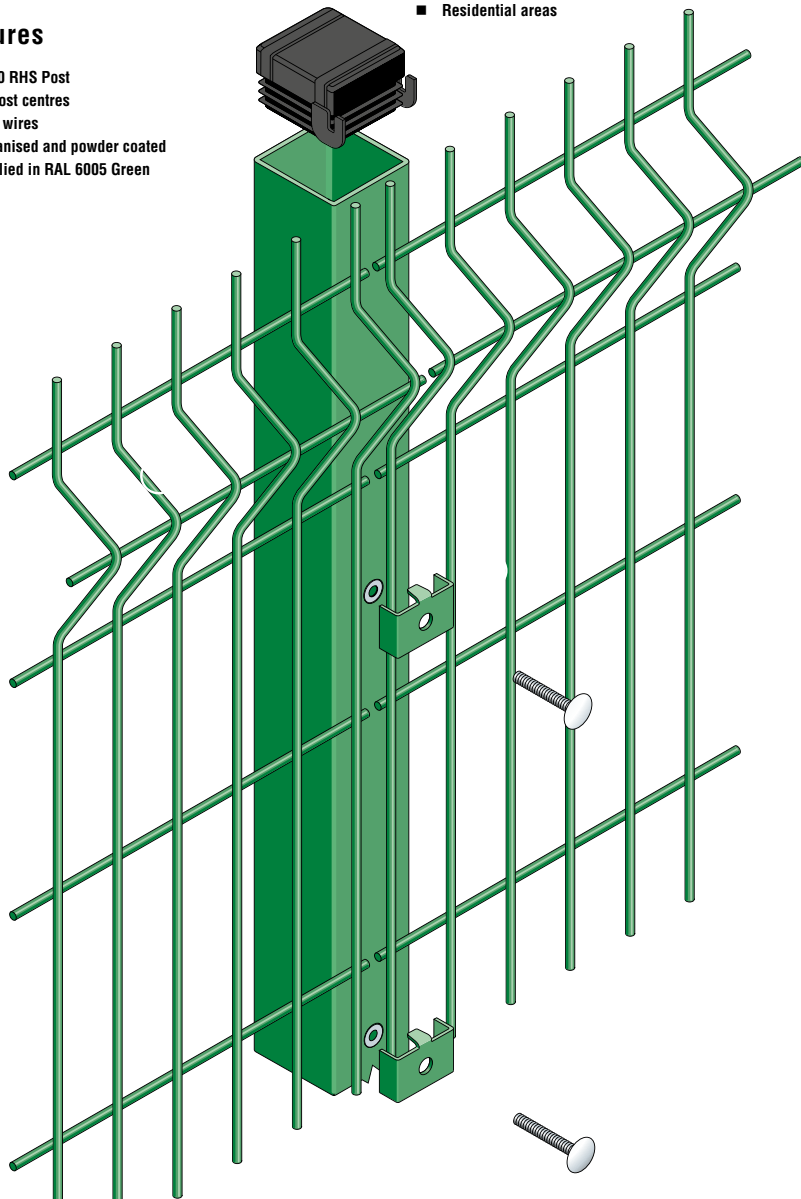

Dimensions

Mesh size: 200 x55mm
 Wire dia: 5mm
 Top edge projection: 30mm
 Triangular folds: 3
 Panel width: 3000mm

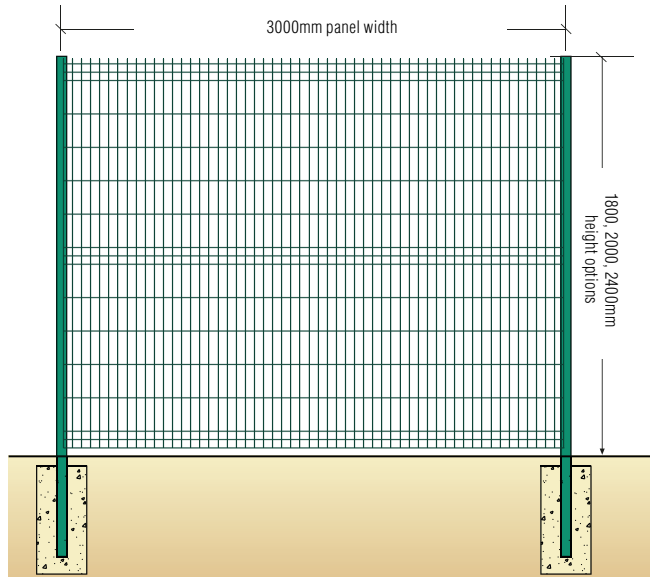

Unique end caps supports panel during fitting enabling one-man installation.

1.8m Fencing

Ref	Kit	Description
32101	3m Kit	1.8m high fencing - 3m wide panel, 1 in-line post and all fixings.

2.0m Fencing

Ref	Kit	Description
33101	3m Kit	2.0m high fencing - 3m wide panel, 1 in-line post and all fixings.

2.4m Fencing

Ref	Kit	Description
34101	3m Kit	2.4m high fencing - 3m wide panel, 1 in-line post and all fixings.

NB CORNER POSTS and FIXING KITS are available as spare parts.

MORE THAN STEEL

ULTRA MESH GATES & ACCESS CONTROL



4D adjustable
anti-lift-off hinge



Security Handle/Lock



Our gates are manufactured from galvanised steel with matching mesh infill, then polyester powder coated in RAL 6005 Green

Gate kits come supplied with our unique hinge sets with integral industrial locks, 3 keys and steel drop bolts

Single leaf

Ref	Height	Description
35101	1.8m	1.2m wide single leaf gate including hinge sets, locks, keys and steel drop bolts.
35102	2.0m	
35103	2.4m	

Double leaf

Ref	Height	Description
36101	1.8m	4.0m wide single leaf gate including hinge sets, locks, keys and steel drop bolts.
36102	2.0m	
36103	2.4m	

Gates are available with a range of access solutions.
Please call for assistance.



Code Lock



Mag Lock



Fire Escape



Child Proof Lock

GATE KITS PALISADE GATE

- Single or double leaf
- Leaf Width: 1.2 to 10m
- Leaf Height: 1.8 to 3m
- Galvanised as Standard (PPC finish as an option)
- Option: Dig in or Bolt-down
- Kit contains all nuts, bolts and fixtures except for cement and ground anchor bolts

Leaf Height (mm)		Leaf Width (mm)	
Min.	Max.	Min.	Max.
1200	10000	1800	3000

MESH GATE

- For pedestrian and vehicle applications
- Flush finish (mesh is inlaid into the frame)
- Single or double leaf
- Leaf Width: 1.2, 4 and 5m
- Leaf Height: 1.8, 2, 2.4 and 3m
- Option for twin mesh (656 or 868), for V-Mesh and for 358 prison mesh
- RAL Available: Green 6005, Black 9005, Blue 5010, Red 3020, Brown 8014, Grey 7037
- Option: Dig in or Bolt-down
- Includes sliding latch bolt
- Kit contains all nuts, bolts and fixtures except for cement and ground anchor bolts

Leaf Height (mm)	Leaf Width (mm)
1800, 2000, 2400 and 3000	1200, 4000, 5000

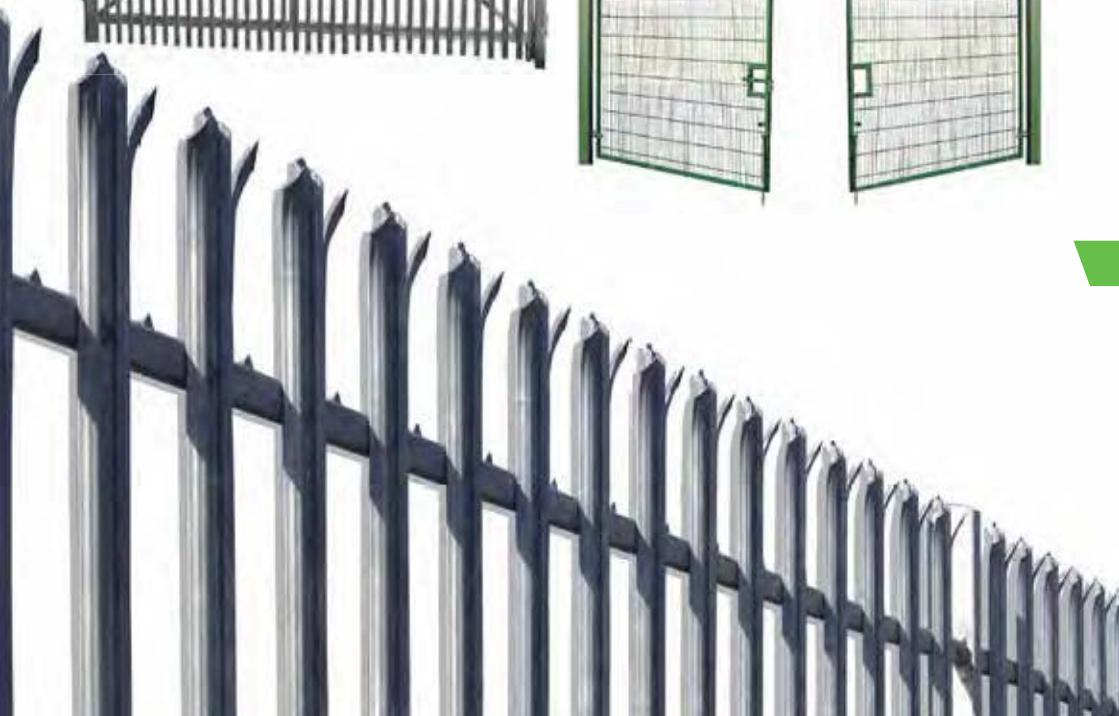
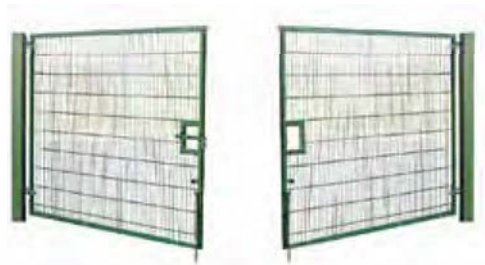

MORE THAN STEEL

BOW TOP FENCE & GATE KITS

BOW TOP GATE KIT

- For pedestrian and public applications (hardwearing and child-safe)
- Single or double leaf
- Galvanised steel
- RAL Available: Green 6005, Black 9005, Blue 5010, Red 3020, Brown 8014, Grey 7037
- Option: Dig in or Bolt-down
- Includes sliding latch bolt
- Kit contains all nuts, bolts and fixtures except for cement and ground anchor bolts



Standard Leaf Heights (mm)	Standard Leaf width (mm)	
	Single	Double
1000, 1200, 1500, 1800, 2100, 2400	2000, 3000, 4000, 5000	6000, 7000, 8000, 9000, 10000

BOW TOP PANEL

- Non-raking railing modular system
- Galvanised steel, Polyester Powder Coating (Standard RAL colours)
- Standard bay Width: 2.75m (distance between post centres)
- Standard Height: 1, 1.2, 1.5, 1.8, 2.1 and 2.4m
- Option: Dig in or Bolt-down



Standard Heights (mm)	Standard bay width (mm)
1000, 1200, 1500, 1800, 2100, 2400	2750



ULTRABOW RAILING SYSTEM

- **Standard 3000m bay width** (for quicker installation).
- **Easy to erect.**
- **Low maintenance.**
- **Self raking**
- **Matching gates available** (call for details).
- **Can be powder coated any colour**

The UltraBow system is developed for easy installation and supplied with pre-assembled panels that simply bolt into place.

Ref	Height	Description
-	1000mm	3000mm systems come with all fixings (additional spar parts available on request). A third rail comes as standard on 2.4m high systems.
-	1200mm	
-	1500mm	
-	1800mm	
-	2000mm	
-	2100mm	
-	2400mm	

Featuring a patented racking joint system gives the installer up to 20 degrees of installation angle instantly.

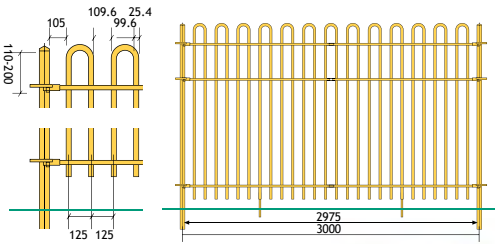

**FOR A FAST,
COMPETITIVE QUOTE
CALL NOW!**

MORE THAN STEEL

GRP PRODUCTS

SECTION GUIDE

GRP BENEFITS.....	99
SAFEGRATING-M	100
SAFEGRATING-P	101
SAFETOP AND SAFEPLANK.....	102
GRP CLIPS.....	103
SAFETREADS AND SAFECOVERS	104
SAFENOSE.....	105
GRP SHEETS.....	105
GRP PROFILES	106
GRP-HANDRAIL	109
GRP-PEDESTAL FEET.....	110

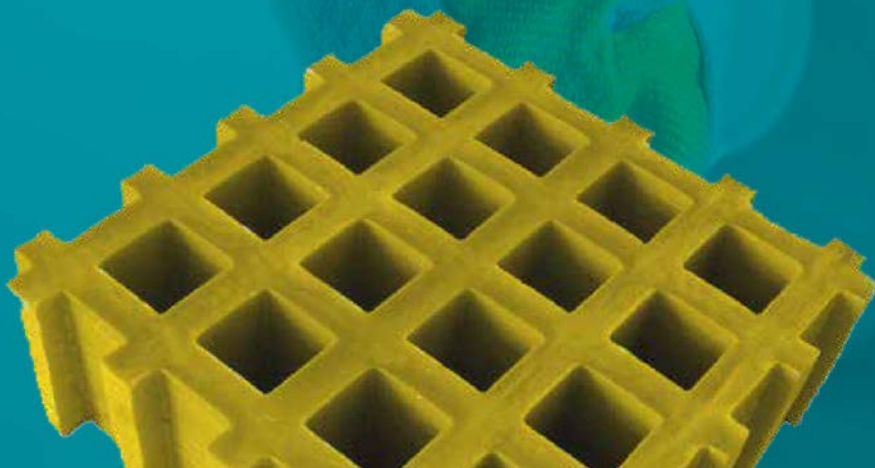

GRP BENEFITS

- Chemical & Corrosion-resistant: ideal for waste and water treatment industries
- Chemical-resistant: ideal for petrochemical projects
- Light weight: ideal for transport & rail sector
- Fire retardant: ideal for offshore/marine applications
- Non-conductive and non-magnetic: ideal for the power distribution market
- Maintenance free: Long life cycle
- Low installation and fabrication cost: Economical material
- Anti-slip: help to meet Health & Safety and DDA regulations
- Impact-resistant: as strong as steel but 60% lighter

-  LIGHT WEIGHT
-  LOW COST
-  FIRE RETARDANT
-  MAINTENANCE FREE
-  SUPER STRONG



RESIN Selection Guide

Type	Applications	Chemical Resistance	Fire Retardant ASTM E84	Certification
Isophthalic Polyester	Industrial	★ ★ ★ ★	Class A, 25 or less	ABS
Isophthalic Vinylester	High Chemical Resistance	★ ★ ★	Class A, 25 or less	ABS
Phenolic	Off Shore Petrochemical where high fire resistance is required	★ ★ ★	Class A, 10 or less	USCG L2/ABS/DNV

Approvals



Det Norske Veritas



US Coast Guard



ABS Approved

MORE THAN STEEL

GRP SAFEGRATING - M

- Moulded Square mesh
- No specific span direction
- Ex-stock: pre-gritted (concave available on demand)
- Fire-retardant
- Available in Dark Grey (RAL7043), Light Grey (RAL 7047), Green (RAL6017) & Yellow (RAL1023)
- Fabricated to size



Depth (mm)	Mesh Size (mm) Centre	Thickness (mm)	Panel Size (mm)	Open Area %	Approx Weight (kg/m ²)	Standard Surface	Standard Colours
14	19 x 19	7	3687 x 1247	42%	43Kg	Grittied	Biege Black Green Grey Yellow
22	19 x 19	7	2007 x 1507	42%	39Kg	Grittied	Biege
		7	3007 x 1007		39Kg		Green Grey
		7	4047 x 1247		65Kg		
25	38 x 38	7	3660 x 1220	70	54Kg	Grittied	Green Grey Yellow
30	38 x 38	7	3660 x 1220	70	75Kg	Grittied	Green Grey
38	38 x 38	7	3660 x 1220	70	80Kg	Grittied	Green Grey Yellow
50	50 x 50	8	3660 x 1220	78	98Kg	Grittied	Green Grey Yellow

Mesh Sizing

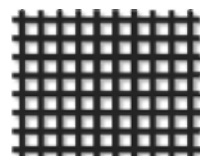
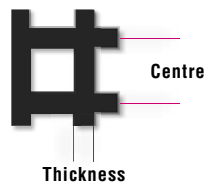

19 x 19mm Mini-Mesh

Uniform Distributed Load Table

Span (mm)	25mm		38mm		50mm	
	UDL kN/m ²	Deflection (mm)	UDL kN/m ²	Deflection (mm)	UDL kN/m ²	Deflection (mm)
500	7.96	2.5	22.74	2.5	39.89	2.5
600	4.61	3.0	13.16	3.0	28.37	3.0
700	3.01	3.5	9.04	3.5	17.87	3.5
800	2.02	4.0	6.77	4.0	14.09	4.0
900	1.42	4.5	4.76	4.5	10.28	4.5
1000			3.47	5.0	7.49	5.0
1100			2.61	5.5	5.9	5.5
1200			2.14	6.0	4.6	6.0
1300			1.69	6.5	3.62	6.5
1400			1.35	7.0	2.9	7.0
1500					2.36	7.5

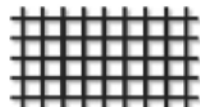

38 x 38 mm

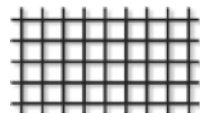

50 x 50mm

GRP SAFEGRATING-P

- Pultruded rectangular grating
- Looks similar to open steel flooring
- For wide span applications (up to 1.5m based on 5 Kn/m2 load factor)
- Gritted anti-slip top surface.
- Available in Grey (RAL7043) & Yellow (RAL1023)
- Fabricated to size

Type	Depth	Grid Size	Mesh Size	Approx Weight	Surface Type	Colour
Pultruded	25mm	6000 x 1000mm	38 x 152mm	13 Kg/m ²	Gritted	Yellow (Ral 1023) Grey (Ral 7043)
Pultruded	38mm	6000 x 1000mm	38 x 152mm	15 Kg/m ²	Gritted	Yellow (Ral 1023) Grey (Ral 7043)



Span (mm)	25mm		38mm	
	UDL kN/m ²	Deflection (mm)	UDL kN/m ²	Deflection (mm)
500	42.18	2.5	111.89	2.5
600	24.41	3.0	64.75	3.0
700	16.09	3.5	44.11	3.5
800	10.78	4.0	29.55	4.0
900	7.78	4.5	22.05	4.5
1000	5.67	5.0	16.07	5.0
1100	4.35	5.5	12.08	5.5
1200	3.35	6.0	9.76	6.0
1300	2.64	6.5	7.68	6.5
1400	2.11	7.0	6.15	7.0
1500	1.72	7.5	5.00	7.5

MORE THAN STEEL

GRP SAFETOP

- Moulded Square mesh with 3mm solid top
- Ex-stock: pre-gritted
- Fire-retardant
- Available in Grey (RAL7043) and Green (RAL6017)



Depth (mm)	Thickness (mm)	Panel Size (mm)	Weight/m ² (kg)	Surface Type	Colour
30	7	2000 x 1000 3000 x 1000 3660 x 1220	24	Grit	Grey Green
41	7	2000 x 1000 3000 x 1000 3660 x 1220	30	Grit	Grey Green

GRP SAFEPLANK

- Pultruded grating with an interlocking "tongue & groove" system
- Grittied top surface
- Available in Grey only
- Ideal for trench covers/trap doors
- Good strength qualities (span up to 1.4m based on 5 Kn/m² load factor)
- Fabricated to size

Type	Depth	Grid Size	Mesh Size	Approx Weight	Surface Type	Colour
Plank	40mm	6000 x 500mm	Solid Top	19 Kg/m ²	Grittied	Grey (Ral 7043)

Uniform Distributed Load Table		
Span (mm)	UDL kN/m ²	Deflection (mm)
500	91.48	2.5
600	56.19	3.0
700	36.74	3.5
800	25.24	4.0
900	18.04	4.5
1000	13.32	5.0
1100	10.11	5.5
1200	7.84	6.00
1300	6.20	6.50
1400	4.99	7.00
1500	4.07	7.50

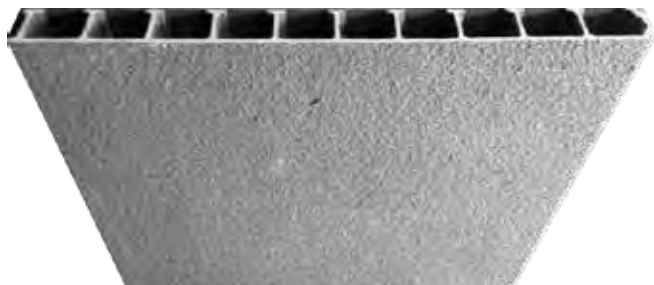

GRP CLIP

- 316 stainless steel
- Non load-bearing clips (help to stop lateral movement only)
- Set to include: top clip and bottom "J" clamp, 50mm long M8 bolt, nut and washer

**FOR A FAST,
COMPETITIVE QUOTE
CALL NOW!**



Clip Type		12mm Mesh Panel	25mm Mesh Panel	38mm Mesh Panel	41mm Mesh Panel	50mm Mesh Panel	14mm Mini Mesh	30mm Mini Mesh
M-Type		451.12	451.25	451.38	N/A	451.50	451.14	451.30
D-Type (Dome)		N/A	N/A	N/A	452.41 (30Ø) 453.41 (45Ø)	N/A	N/A	N/A
S-Type (Square)		N/A	N/A	454.38	N/A	N/A	N/A	N/A
G Type (Panel to Panel)		N/A	455.25	4550.38	N/A	455.50	N/A	N/A

GRP SAFETREADS

- Moulded Square grating
- Similar look to steel flooring
- For wide span applications (up to 1.5m based on 5 Kn/m² load factor)
- Gritted anti-slip top surface.
- Available in Grey (RAL7043), Yellow (RAL1023) & Green (RAL6017) with Hi-Vis to suit



GRP SAFECOVERS

- Standard 6mm thick with a 55mm deep drop (available up to 60mm)
- Standard size – 1200mm x 300mm
- (other sizes on demand)
- Standard Colours – Grey / Yellow or Black / Yellow
- (Complete with a Nosing colour to suit)
- Ideal for retrofit and provide good anti-slip surface
- DDA compliant

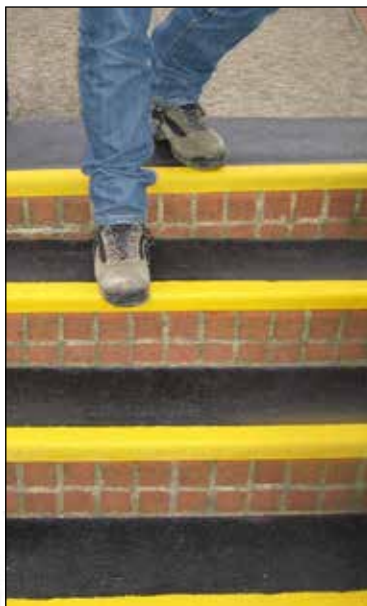

GRP SAFENOSE

- Gives added anti-slip factor to existing Stairs
- Available in two sizes: 55mm x 55mm & 55mm x 70mm
- 3000mm lengths
- Standard colours – Black , White or Yellow
- Easy fit – Screw or Glue
- DDA compliant

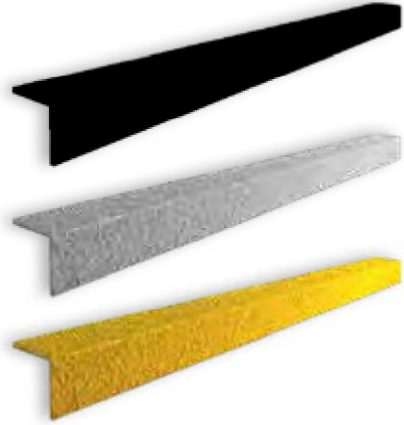

GRP SHEETS

- Ideal to re-vamp old flooring and provide an anti slip surface
- Standard thickness is 3mm – Other thickness's on request.
- Standard panel sizes are 3000mm x 1000mm.
- Easy to fit – screw or glue
- Standard colours – Black & Yellow (other colours available)
- Fire-resistant to BS 476, up to Part 7, Class 2 & Phenolic



Finishing:

- Smooth / Crinkle
- Smooth / Smooth
- Smooth / Leatherette
- Crinkle / Crinkle
- Leatherette / Leatherette
- Smooth / Smooth
- Smooth / Resotex
- Others on request



MORE THAN STEEL

GRP PROFILES

- Pultruded Structural profiles
- Made from glass reinforced isophthalic polyester resin reinforced with E glass fibre and including continuous strand mat and a polyester surface veil as the surface layer
- Ultra light weight with extra strength
- Low electrical and thermal conductivity
- 6m length
- Available in Grey, Yellow & White.

FLAT BARS

Width (mm)	Thickness (mm)	Weight (kg/m)	Colour
80	8	1.2	Grey
926	3.1	5.58	Grey



W

ANGLES

L1 Leg Length (mm)	L2 Leg Length (mm)	Thickness (mm)	Weight (kg/m)	Colour
25	25	3	0.270	Grey
50	50	3	0.550	Grey
50	50	5	0.960	Grey
51	51	6.35	1.150	Grey
60	60	8	1.750	Grey
75	75	10	2.700	Grey
100	100	8	2.950	Grey

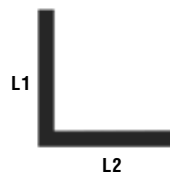

L1

L2

I AND H BEAMS

Width (mm)	Height (mm)	Thickness (mm)	Weight (kg/m)	Colour
70	120	8	3.77	Grey
80	150	10	5.71	Grey
100	200	9.5	7.20	Grey
200	200	10	11.02	Grey



H

W

TOE RAIL (KICK-PLATE)

Dimensions (mm)	Weight kg/m	Colour
150 x 3	1.30	Grey / Yellow

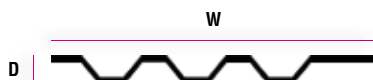

W

D

GRP PROFILES

U CHANNELS

Width (mm)	Leg Length (mm)	Thickness (mm)	Weight (kg/m)	Colour
50*	30	4	0.75	Grey & Yellow
76	25.4	6.35	1.25	Grey
100	50	6	2.18	Grey
150	50	6	2.75	Grey
200	60	8	4.68	Grey
200	60	9.5	5.74	Grey
280	70	12.5	9.27	Grey

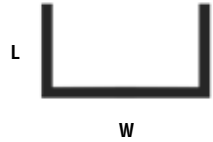

SQUARES AND RECTANGLES

B1 Side (mm)	B2 Side (mm)	Thickness (mm)	Weight (kg/m)	Colour
25	25	3	0.55	Grey
38	38	3.2	0.80	Grey & Yellow
38	38	5	1.24	Grey & Yellow
44	44	6	1.70	Grey & Yellow
51	51	3.25	1.13	Grey & Yellow
51	51	6.35	2.17	Grey & Yellow
60	60	4.25	1.85	Grey & Yellow
76	76	6.35	3.56	Grey
102	51	6.35 / 3.25	2.34	Grey
101.6	101.6	6.35	4.60	Grey

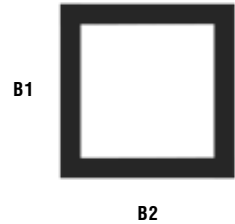

UNISTRUT PROFILE

Width (mm)	Height (mm)	Thickness (mm)	Weight (kg/m)	Colour
41.5	41.5	3.5	0.92	Grey

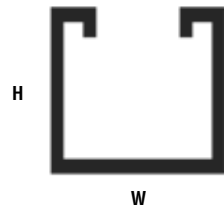

MORE THAN STEEL

GRP PROFILES CONTD..

SOLID ROUND RODS

Diameter (mm)	Weight (gm/m)	Stock Length (m)	Colour
5	40	6	Black
6	50	6	White & Black
7	70	6	White & Black
8	100	6	White & Black
9.5	160	6	White
12.7	220	6	White
16	400	6	White

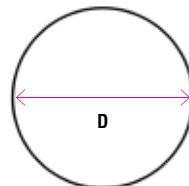

TUBES

OD (mm)	ID (mm)	Wall Thickness (mm)	Weight (gm/m)	Stock Length (m)	Colour
7.9	3.3	2.3	80	6	Black
9.5	3	3.25	100	6	Black
12.5	4	4.35	200	6	Black
19	13	3.2	290	6	White
22*	17	2.5	280	6	Grey
25*	20	2.5	330	6	Grey
31	25	3.0	521	6	Yellow & Grey
38	32	3.0	620	6	Yellow & Grey
48.5**	35	6.75	1600	6	Red & Yellow
50	40	5	1300	5	Yellow
51.6	46.5	2.55	720	6	Grey

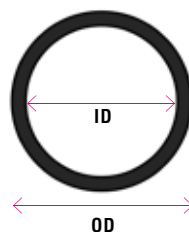

* Available in high gloss finish

** The 48.5 x 35 tube is the scaffold tube

RODS: Technical Data

Property	Units	Data
Tensile Strength	MPa	550
Tensile Modulus	GPa	30
Density	g/cc	1.9
Electrical Strength	kV/mm	10
Thermal Conductivity	W/m.K	0.35
Water Absorption	% wt/wt	0.2%

TUBES: Technical Data

Property	Units	Data
Tensile Strength	MPa	170
Tensile Modulus	GPa	17
Flexural Strength	MPa	170
Density	g/cc	1.8
Electrical Strength	kV/mm	10
Thermal Conductivity	W/m.K	0.35
Water Absorption	% wt/wt	0.2%

GRP HANDRAIL



Ref:	Description
42101	Round Tube 50mm OD x 40mm ID



Ref:	Description
42102	W Toe plate (kick plate)



Ref:	Description
42103	3 way connection Tee connection



Ref:	Description
42105	90 Deg Elbow



Ref:	Description
42107	Universal Joint



Ref:	Description
42109	Stanchion Post Base Foot



Ref:	Description
42107	Side Fit



Ref:	Description
42111	Triangle Base Foot



Ref:	Description
42113	3 Way Corner



Ref:	Description
42114	4 Way Corner

MORE THAN STEEL

GRP PEDESTAL FEET

- Adjustable height: from 27.5mm to 550mm (precise adjustment for both height and level)
- Made of polypropylene and rubber to provide anti-noise & anti-slip bedding surface
- Modular system with rings, shims and height extension (extra 25 to 40mm)
- Self-levelling head: to compensate for gradients up to 5°
- Resistant to temperatures from -40 to +120°C
- UV stable and resistant to acids
- Quick and easy to install

**FOR A FAST,
COMPETITIVE QUOTE
CALL NOW!**



**FOR A FAST,
COMPETITIVE QUOTE
CALL NOW!**



Ref:	Height (mm)
41103	75-120



Ref:	Height (mm)
41104	120-200



Ref:	Height (mm)
41101	37.5-50



Ref:	Height (mm)
41102	50-75



Ref:	Height (mm)
41105	190-270



Ref:	Height (mm)
41106	140-230



Ref:	Height (mm)
41107	185-275

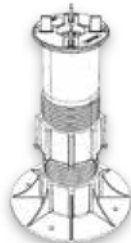

Ref:	Height (mm)
41108	235-325

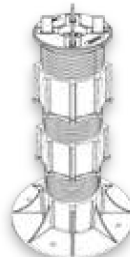

Ref:	Height (mm)
41109	205-345



Ref:	Height (mm)
41110	250-385



Ref:	Height (mm)
41111	300-400

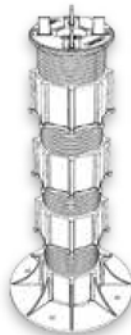

Ref:	Height (mm)
41112	270-455



Ref:	Height (mm)
41113	315-500

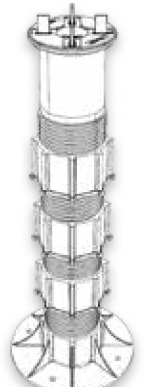

Ref:	Height (mm)
41114	365-550

	Size / Dia (mm)	Ref:
	65 - 100mm	41115
	20 x 2mm Tabs 20 x 2mm Tabs 20 x 2mm Tabs 12 x 2mm Tabs 12 x 3mm Tabs	41116 41117 41118 41119 41120
	N/A	41121
	23 x 2mm Tabs 23 x 3mm Tabs 23 x 4mm Tabs	41122 41123 41124

	Size / Dia (mm)	Ref:
	N/A	KEY
	176mm	Uni-Ring
	110mm	Uni-Shim
	25 - 40mm	Uni-Plus

Reinforced adjustment key

Locating tabs for easy removal if required

Self-levelling head

Coupling head

Screw coupling extension component

Supporting base with drainage holes



Uni-Plus



Uni-Ring

EAZYCLAD ROOFING & CLADDING

SECTION GUIDE

200 ROOF RANGE	115
200 WALL RANGE	116
FLASHINGS	117



THE EAZYCLAD 200 ROOF & WALL RANGE.

QUALITY
CLADDING AT
AFFORDABLE
PRICES.

NEW!
PRODUCT
LINE.

200 ROOF RANGE

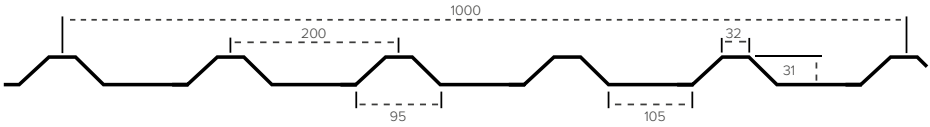

* Available with 50mm swages upon request

DIMENSION DETAILS	
COVER WIDTH	1000mm
PROFILE PITCH	200mm
PROFILE DEPTH	31mm
CROWN WIDTH	32mm
VALLEY WIDTH	105mm
RIB WIDTH	95mm

WEIGHT PER LINEAR METRE	
0.7mm	6.70 kg
0.5mm	4.79 kg

SAFE WORKING LOAD (ULTIMATE / 1.5)

		SPAN (M)																	
GRAVITY	L/200	THICKNESS	1.00	1.10	1.20	1.30	1.40	1.50	1.60	1.70	1.80	1.90	2.00	2.10	2.20	2.30	2.40	2.50	2.60
	SINGLE SPAN	0.7	6.11	5.05	4.24	3.61	3.12	2.62	2.16	1.80	1.52	1.29	1.11	0.96	0.83	0.73	0.64	0.57	0.50
	DOUBLE SPAN	0.7	3.30	2.87	2.52	2.23	1.99	1.78	1.61	1.46	1.34	1.22	1.13	1.04	0.96	0.89	0.83	0.78	0.73
	MULTI SPAN	0.7	3.92	3.41	3.00	2.66	2.38	2.14	1.93	1.76	1.61	1.47	1.36	1.25	1.16	1.08	1.01	0.94	0.88
	SINGLE SPAN	0.5	3.10	2.82	2.59	2.24	1.93	1.68	1.42	1.18	1.00	0.85	0.73	0.63	0.55	0.48	0.56	0.37	0.33
	DOUBLE SPAN	0.5	1.81	1.58	1.39	1.24	1.11	1.00	0.91	0.83	0.76	0.69	0.64	0.59	0.55	0.51	0.48	0.45	0.42
	MULTI SPAN	0.5	2.14	1.87	1.65	1.47	1.32	1.19	1.08	0.99	0.91	0.83	0.77	0.71	0.66	0.62	0.58	0.54	0.51

SAFE WORKING LOAD (ULTIMATE / 1.5)

		SPAN (M)																	
SUCTION	L/200	THICKNESS	1.00	1.10	1.20	1.30	1.40	1.50	1.60	1.70	1.80	1.90	2.00	2.10	2.20	2.30	2.40	2.50	2.60
	SINGLE SPAN	0.7	5.66	4.68	3.93	3.26	2.61	2.12	1.75	1.46	1.23	1.04	0.89	0.77	0.67	0.59	0.52	0.46	0.50
	DOUBLE SPAN	0.7	3.42	2.97	2.61	2.32	2.07	1.86	1.68	1.53	1.40	1.28	1.18	1.09	1.01	0.94	0.86	0.78	0.73
	MULTI SPAN	0.7	4.05	3.53	3.11	2.76	2.47	2.23	2.02	1.84	1.68	1.54	1.42	1.29	1.12	0.98	0.86	0.94	0.84
	SINGLE SPAN	0.5	3.10	2.82	2.42	2.06	1.71	1.39	1.14	0.95	0.80	0.68	0.59	0.51	0.44	0.39	0.34	0.37	0.33
	DOUBLE SPAN	0.5	1.87	1.64	1.45	1.29	1.16	1.04	0.95	0.86	0.79	0.73	0.67	0.62	0.58	0.54	0.50	0.45	0.42
	MULTI SPAN	0.5	2.21	1.94	1.71	1.53	1.37	1.24	1.13	1.03	0.94	0.87	0.80	0.75	0.69	0.64	0.56	0.54	0.51

MORE THAN STEEL

200 WALL RANGE

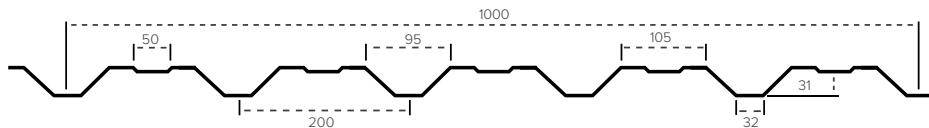

* Available without 50mm swages upon request

DIMENSION DETAILS	
COVER WIDTH	1000mm
PROFILE PITCH	200mm
PROFILE DEPTH	31mm
CROWN WIDTH	32mm
VALLEY WIDTH	105mm
RIB WIDTH	95mm

WEIGHT PER LINEAR METRE	
0.7mm	6.70 kg
0.5mm	4.79 kg

SAFE WORKING LOAD (ULTIMATE / 1.5)

SPAN (M)

GRAVITY	L/200	THICKNESS	1.00	1.10	1.20	1.30	1.40	1.50	1.60	1.70	1.80	1.90	2.00	2.10	2.20	2.30	2.40	2.50	2.60
	SINGLE SPAN	0.7	5.66	4.68	3.93	3.35	2.89	2.51	2.21	1.94	1.64	1.39	1.19	1.03	0.90	0.78	0.69	0.61	0.54
DOUBLE SPAN	0.7	3.42	2.97	2.61	2.32	2.07	1.86	1.68	1.53	1.40	1.28	1.18	1.09	1.01	0.94	0.88	0.82	0.77	
MULTI SPAN	0.7	4.05	3.53	3.11	2.76	2.47	2.23	2.02	1.84	1.68	1.54	1.42	1.31	1.22	1.13	1.06	0.99	0.91	
SINGLE SPAN	0.5	3.10	2.82	2.42	2.06	1.78	1.55	1.36	1.21	1.07	0.91	0.78	0.67	0.59	0.51	0.45	0.40	0.36	
DOUBLE SPAN	0.5	1.87	1.64	1.45	1.29	1.16	1.04	0.95	0.86	0.79	0.73	0.67	0.62	0.58	0.54	0.50	0.47	0.44	
MULTI SPAN	0.5	2.21	1.94	1.71	1.53	1.37	1.24	1.13	1.03	0.94	0.87	0.80	0.75	0.69	0.65	0.60	0.57	0.53	

SAFE WORKING LOAD (ULTIMATE / 1.5)

SPAN (M)









SUCTION	L/200	THICKNESS	1.00	1.10	1.20	1.30	1.40	1.50	1.60	1.70	1.80	1.90	2.00	2.10	2.20	2.30	2.40	2.50	2.60
	SINGLE SPAN	0.7	6.11	5.05	4.24	3.61	3.12	2.71	2.39	2.11	1.88	1.69	1.47	1.27	1.11	0.97	0.85	0.76	0.67
DOUBLE SPAN	0.7	3.30	2.87	2.52	2.23	1.99	1.78	1.61	1.46	1.34	1.22	1.13	1.04	0.96	0.89	0.83	0.78	0.73	
MULTI SPAN	0.7	3.92	3.41	3.00	2.66	2.38	2.14	1.93	1.76	1.61	1.47	1.36	1.25	1.16	1.08	1.01	0.94	0.88	
SINGLE SPAN	0.5	3.10	2.82	2.59	2.24	1.93	1.68	1.48	1.31	1.17	1.05	0.95	0.84	0.73	0.64	0.56	0.50	0.44	
DOUBLE SPAN	0.5	1.81	1.58	1.39	1.24	1.11	1.00	0.91	0.83	0.76	0.69	0.64	0.59	0.55	0.51	0.48	0.45	0.42	
MULTI SPAN	0.5	2.14	1.87	1.65	1.47	1.32	1.19	1.08	0.99	0.91	0.83	0.77	0.71	0.66	0.62	0.58	0.54	0.51	

FLASHINGS

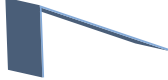
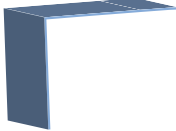
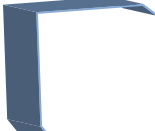
WHAT WE OFFER

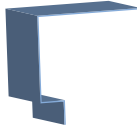
The construction industry demands a wide and varied range of products to finish metal buildings and close the joints where building elements meet. These include everything from standard perimeter flashings to ridge closures and drip flashings. If an attractive, functional finish is needed to complete a metal building envelope then the sensible choice for flashings is here.

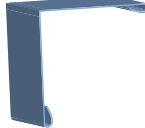
Available in a range of colours, we can supply highly finished flashings that are expertly manufactured, delivered on-time and perfectly match, complement or contrast the roof and wall cladding. Ridge vents are available for ventilated constructions, especially useful to complement the DRIPSTOP condensation control fleece.

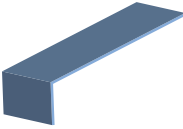
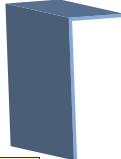
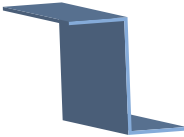
<p>RIDGE</p>  <p>Ref: 7101</p>	<p>RIDGE WITH STIFFENERS</p>  <p>Ref: 7102</p>	<p>RIDGE WITH WELTS</p>  <p>Ref: 7103</p>	<p>MONO RIDGE</p>  <p>Ref: 7104</p>
<p>BARGEBOARD</p>  <p>Ref: 7105</p>	<p>BARGEBOARD WITH STIFFENERS</p>  <p>Ref: 7106</p>	<p>SQUARE DOWNPIPE</p>  <p>Ref: 7107</p>	<p>SHADOWLINE BARGEBOARD</p>  <p>Ref: 7108</p>
<p>VALLEY GUTTER</p>  <p>Ref: 7109</p>	<p>TRIMLWTER</p>  <p>Ref: 7110</p>	<p>BARGEBOARD WITH WELTS</p>  <p>Ref: 7111</p>	<p>EXPANSION JOINT</p>  <p>Ref: 7112</p>
<p>DRIP/CILL</p>  <p>Ref: 7113</p>	<p>EAVES</p>  <p>Ref: 7114</p>	<p>JAMB</p>  <p>Ref: 7115</p>	<p>Z SPACER FLASHING</p>  <p>Ref: 7116</p>

MORE THAN STEEL

WROUGHT IRON + GATE SYSTEMS

SECTION GUIDE

RAIL HEADS	119
BUSHED AND POST TOPS	121
SCROLLS	123
CLIP-ON UNITS	124
SHAPED BAR	125
CIRCLES AND BASKETS	129
BAR FOR RAILINGS	130
FORGED BAR	132
PANEL UNITS AND ROSETTES	133
COD ROLLED BAR	135
TWISTED PROFILES	135
GATE HINGES AND ACCESSORIES	139
SLIDING GATE SYSTEMS	142



RAILHEAD ROUND BASE



Ref:	Width (mm)	Height (mm)	Ø (mm)
81-13048	57	114	21



Ref:	Width (mm)	Height (mm)	Ø (mm)
81-13049	72	135	27



Ref:	Width (mm)	Height (mm)	Ø (mm)
81-13053	70	155	16



Ref:	Width (mm)	Height (mm)	Ø (mm)
81-13056	64	125	25



Ref:	Width (mm)	Height (mm)	Ø (mm)
81-13073	47	169	29



Ref:	Width (mm)	Height (mm)	Ø (mm)
81-13074	53	195	33



Ref:	Width (mm)	Height (mm)	Ø (mm)
81-13075	59	175	36



Ref:	Width (mm)	Height (mm)	Ø (mm)
81-137271	71	140	32



Ref:	Width (mm)	Height (mm)	Ø (mm)
81-737272	67	124	30

MORE THAN STEEL



NEW!
PRODUCT
LINE.

Ref:	Width (mm)	Height (mm)	Ø (mm)
81-13052	60	130	12



Ref:	Width (mm)	Height (mm)	Bar (mm)
81-13092	30	125	20



Ref:	Width (mm)	Height (mm)	Bar (mm)
81-13093	52	154	30



Ref:	Width (mm)	Height (mm)	Bar (mm)
81-13095	27	96	12

BUSHES & POST TOPS

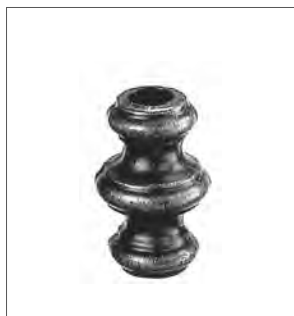

Ref:	Width (mm)	Height (mm)	Ø (mm)
81-13138	40	67	12.5



Ref:	Width (mm)	Height (mm)	Ø (mm)
81-13140	40	67	16.5



Ref:	Width (mm)	Height (mm)	Ø (mm)
81-13159	50	80	16.5



Ref:	Width (mm)	Height (mm)	Ø (mm)
81-1322104	55	85	45



Ref:	Width (mm)	Height (mm)	Ø (mm)
810-1321401	-	90	40

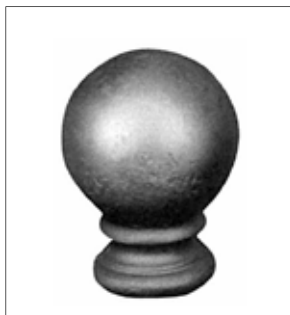

Ref:	Width (mm)	Height (mm)	Ø (mm)
81-1322103	70	100	55

MORE THAN STEEL



Ref:	Width (mm)	Height (mm)	Ø (mm)
81-1322402	-	65	30



Ref:	Width (mm)	Height (mm)	Ø (mm)
81-13240	-	-	16
81-13241	-	-	20
81-13242	-	-	25
81-13243	-	-	30
81-13244	-	-	35
81-13245	-	-	40
81-13246	-	-	50
81-13247	-	-	60
81-13248	-	-	70
81-13248.01	-	-	75



Ref:	Width (mm)	Height (mm)	Ø (mm)
81-13251	-	-	100



Ref:	Width (mm)	Height (mm)	Ø (mm)
81-13250	-	-	90

**FOR A FAST,
COMPETITIVE QUOTE
CALL NOW!**

SCROLLS

'S' SCROLLS



Ref:	Height (mm)	Length (mm)	Bar (mm)
82-01022	220	110	12x6



Ref:	Height (mm)	Length (mm)	Bar (mm)
82-01024	220	110	20x6



Ref:	Height (mm)	Length (mm)	Bar (mm)
82-01026	290	120	16x4



Ref:	Height (mm)	Length (mm)	Bar (mm)
82-01028	290	120	12x6



Ref:	Height (mm)	Length (mm)	Bar (mm)
82-01042	290	120	12x6



Ref:	Height (mm)	Length (mm)	Bar (mm)
82-01044	290	120	20x6



Ref:	Height (mm)	Length (mm)	Bar (mm)
82-04032	720	130	20x6

NEW!
PRODUCT
LINE.

CLIP-ON UNIT

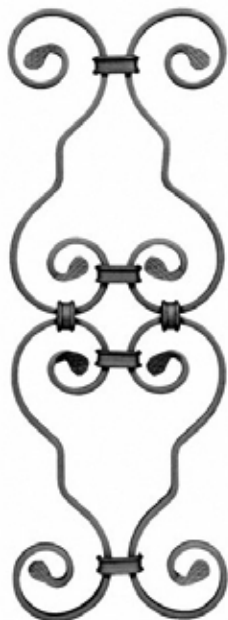

Ref:	Height (mm)	Length (mm)	Bar (mm)
82-03045	480	170	12x6



Ref:	Height (mm)	Length (mm)	Bar (mm)
82-03047	410	200	12x6



Ref:	Height (mm)	Length (mm)	Bar (mm)
82-03053	95	95	12x6



Ref:	Height (mm)	Length (mm)	Bar (mm)
82-03054	100	100	12x6

SHAPED BAR

Hammer-Twist



Ref:	Height (mm)	Length (mm)	Bar (mm)
82-04099	950	200	12
82-04100	1200	200	12

Smooth-Twist



Ref:	Height (mm)	Length (mm)	Bar (mm)
82-0409825	950	200	12
82-0409826	1200	200	12

SHAPED BAR

Hammer



Ref:	Height (mm)	Length (mm)	Bar (mm)
82-04103	950	200	12



Ref:	Height (mm)	Length (mm)	Bar (mm)
82-04057	720	250	12
82-0410605	950	200	12
82-0410606	1200	200	12

Round Bar



Ref:	Height (mm)	Length (mm)	Ø (mm)
82-0410613	950	200	14
82-0410614	1200	200	14

SHAPED BAR



Ref:	Height (mm)	Length (mm)	Bar (mm)
82-04107	950	200	12



Ref:	Height (mm)	Length (mm)	Bar (mm)
82-0411005	950	200	12



CIRCLES & BASKETS



Ref:	Height (mm)	Ø (mm)
83-02008	120	12



Ref:	Height (mm)	Bar (mm)
83-02017	120	12



Ref:	Height (mm)	Bar (mm)
83-02020	120	16x4



Ref:	Height (mm)	Bar (mm)
83-02032	120	12x6



Ref:	Height (mm)	Bar (mm)
83-02042	100	16x8



Ref:	Height (mm)	Bar (mm)
83-02043	120	16x8

Fishtail End

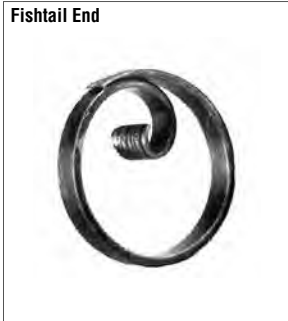

Ref:	Height (mm)	Bar (mm)
83-02065.02	120	12x6



Ref:	Height (mm)	Length (mm)	Base (mm)
83-02080	130	60	12



Ref:	Height (mm)	Length (mm)	Base (mm)
83-02082	160	70	16

BAR FOR RAILINGS



Ref:	Height (mm)	Ø (mm)
811-18130921	1125	12

BAR FOR RAILINGS



Ref:	Height (mm)	Ø (mm)
811-18130521	1130	12



Ref:	Height (mm)	Ø (mm)
811-18130531	1155	16



Ref:	Height (mm)	Ball (mm)	Ø (mm)
84-181324403	900	35	12
84-181324212	1200	25	12
84-181324412	1200	35	16

FORGED BARS



Ref:	Length (mm)	Bar (mm)
84-12146	3000	12



Ref:	Length (mm)	Bar (mm)
84-12148	3000	16



PANEL UNITS & ROSETTES



Ref:	Height (mm)	Width (mm)	Bar (mm)
86-05066	950	165	12x6



Ref:	Height (mm)	Width (mm)	Bar (mm)
86-05068	950	170	12x6



Ref:	Height (mm)	Width (mm)	Bar (mm)
86-05067	950	170	12x6

**FOR A FAST,
COMPETITIVE QUOTE
CALL NOW!**

MORE THAN STEEL



COLD ROLLED BAR

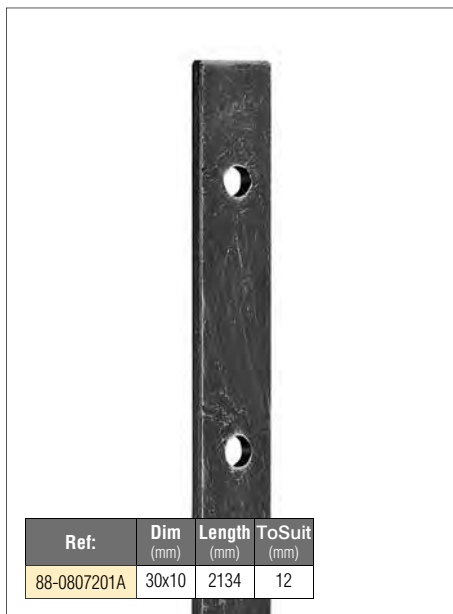
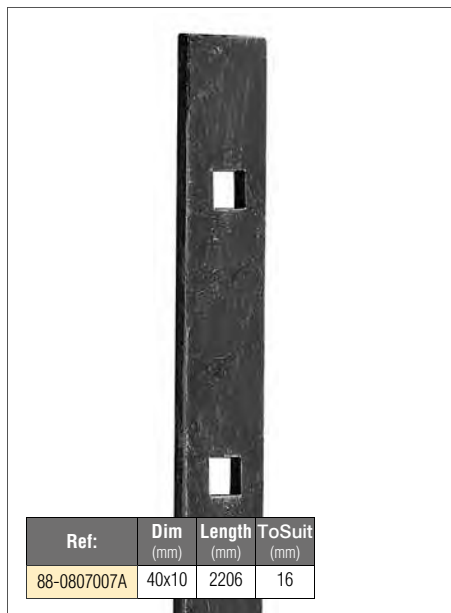
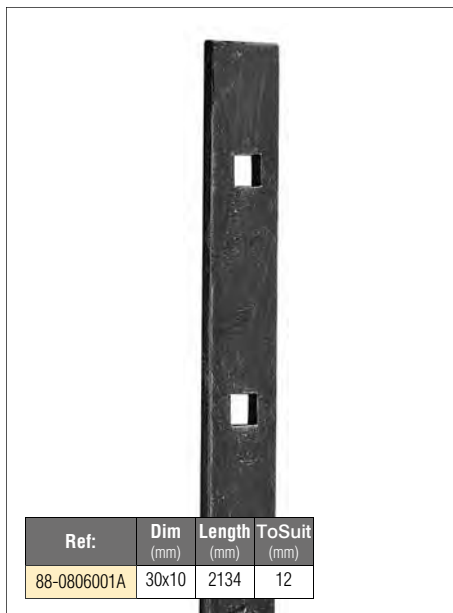

TWISTED PROFILES

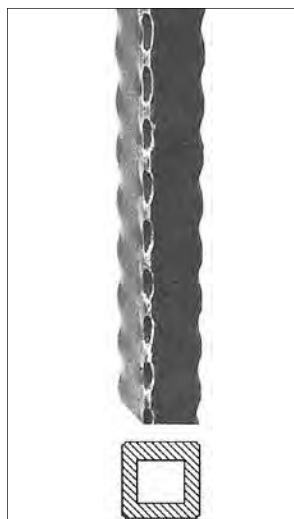

Ref:	Profile (mm)	Length (mm)
89-00030252	25x25	3000



Ref:	Profile (mm)	Length (mm)
89-00040483	14	1000



Ref:	Profile (mm)	Length (mm)
89-06001	12	950

Single Twist

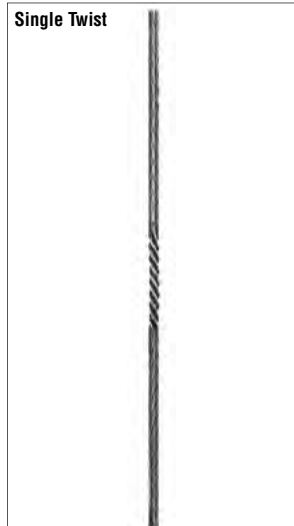

Ref:	Profile (mm)	Length (mm)
89-06003	12	950

Double Twist

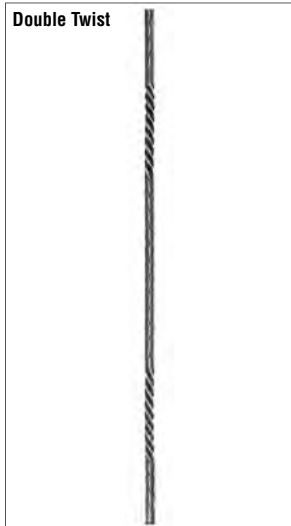

Ref:	Profile (mm)	Length (mm)
89-06004	12	950



Ref:	Profile (mm)	Length (mm)
89-1200612	12	3000



Ref:	Length (mm)	Height (mm)	Profile (mm)
89-1208601	260	240	40x12

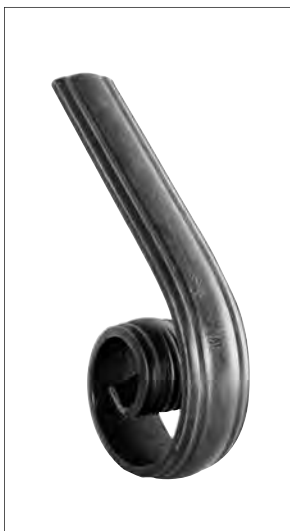

Ref:	Length (mm)	Height (mm)	Profile (mm)
89-1208701	400	160	40x12

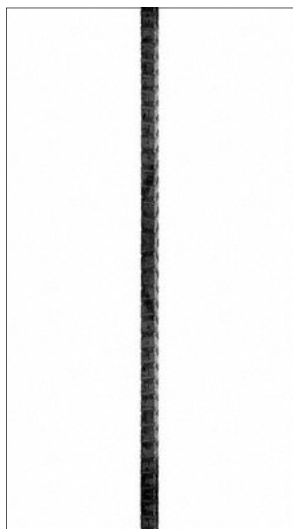

Ref:	Length (mm)	Height (mm)	Profile (mm)
89-12213	3000	-	12

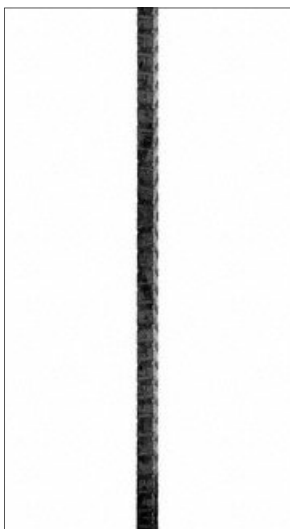

Ref:	Length (mm)	Height (mm)	Profile (mm)
89-12215	3000	-	16



Ref:	Length (mm)	Height (mm)	Profile (mm)
89-12217	3000	-	20

MORE THAN STEEL



Ref:	Height (mm)	Gap (mm)	Profile (mm)
89-1303550	250	100	12



Ref:	Height (mm)	Profile (mm)
89-135113	-	51x13x6.1



Ref:	Height (mm)	Length (mm)	Profile (mm)
89-1501807	350	-	50x8

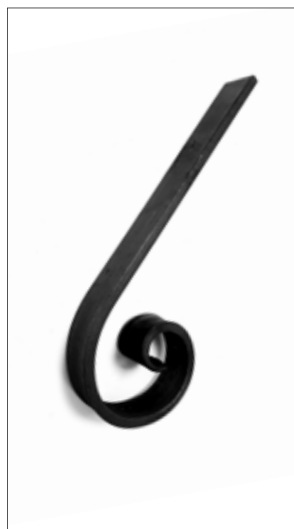

Ref:	Height (mm)	Length (mm)	Profile (mm)
89-1599903	300	-	30x8

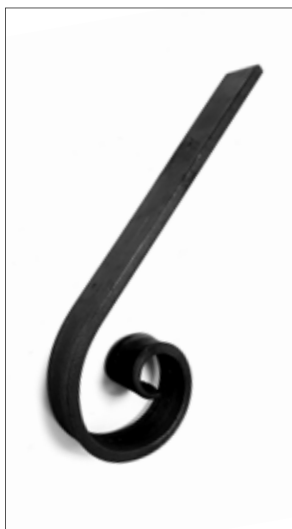

Ref:	Height (mm)	Length (mm)	Profile (mm)
89-1599904	300	-	40x10

GATE HINGES & ACCESSORIES



Ref:	Description
812-00126	Gate Eye Bolt Adjustable M12 x 150, C/W 2 Nuts



Ref:	Description
812-00166	Gate Eye Bolt Adjustable M16 x 150, C/W 2 Nuts



Ref:	Description
812-002410	Gate Eye Bolt Adjustable M24 x 250, C/W 2 Nuts, 250mm threaded



Ref:	Description
812-00246	Gate Eye Bolt Adjustable M24 x 150, C/W 2 Nuts, 150mm threaded

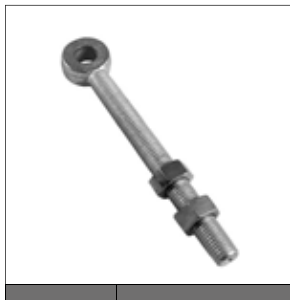

Ref:	Description
812-02124	Gate Eye Bolt Adjustable M12 x 100, C/W 2 Nuts, Galvanized.



Ref:	Description
812-021164	Gate Eye Bolt Adjustable M16 x 100, C/W 2 Nuts, Galvanized.



Ref:	Description
812-15052	Post Cap, 30mm Square with Flange



Ref:	Description
812-15053	Post Cap, 40mm Square with Flange



Ref:	Description
812-15054	Post Cap, 50mm Square with Flange

MORE THAN STEEL



Ref:	Description
812-1505905	Post Cap, 40mm Diameter Ball x 30mm Square Base



Ref:	Description
812-1505906	Post Cap, 40mm Diameter Ball x 40mm Square Base



Ref:	Description
812-1505907	Post Cap, 50mm Diameter Ball x 50mm Square Base



Ref:	Description
812-1012	Gate Eye 12mm for Welding-on, 30 x 40 x 12mm at 26mm Centre



Ref:	Description
812-1016	Gate Eye 16mm for Welding-on, 40mm x 15mm at 38mm Centre



Ref:	Description
812-1025	Gate Eye 25mm for Welding-on, 70mm x 20mm x 45mm Centre



Ref:	Description
812-2012	Gate Hook Pin for Welding-on 12mm, 40mm x 30mm x 12mm



Ref:	Description
812-2016	Gate Hook Pin for Welding-on 16mm, 40mm x 15mm at 38mm Centre



Ref:	Description
812-2025	Gate Hook Pin for Welding-on 25mm, 50mm x 25mm x 70mm



Ref:	Description
812-8805	12mm Drop Bar Guide
812-8806	16mm Drop Bar Guide
812-8807	20mm Drop Bar Guide



Ref:	Description
812-8808	65mm Drop Bar Guide





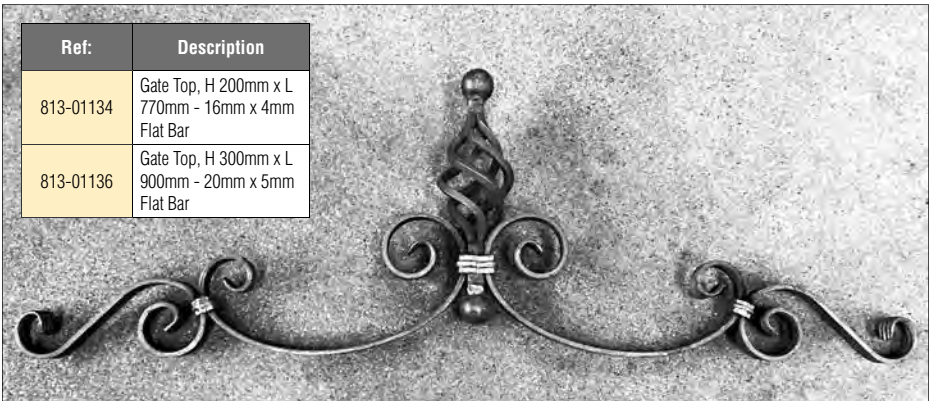

Ref:	Description
812-8809	Forged Drop Bar, 12 x 600mm
812-8810	Forged Drop Bar, 16 x 600mm
812-8811	Forged Drop Bar, 20 x 600mm



Ref:	Description
813-01134	Gate Top, H 200mm x L 770mm - 16mm x 4mm Flat Bar
813-01136	Gate Top, H 300mm x L 900mm - 20mm x 5mm Flat Bar

SLIDING GEAR

SWING GATE ACCESSORIES

Adjustable Gate Hinge			
	51301.18 Long thread hinge, Galvanised. M18		51305.18 Weld-on hinge, Galvanised. M18 51306.22 Weld-on hinge, Galvanised. M22 51307.27 Weld-on hinge, Galvanised. M27
	51302.18 Short thread hinge, Galvanised. M18 51303.27 Short thread hinge, Galvanised. M27		51308.18 Adjustable hinge with plate, Galvanised. M18 51309.22 Adjustable hinge with plate, Galvanised. M22 51310.27 Adjustable hinge with plate, Galvanised. M27
	51304.18 Adjustable hinge, Galvanised. M18		

GATE IRONMONGARY - Locks for Swing Gates

- Non handed
- Throw of the deadbolt, 23mm in 1 turn of the key
- Centre distance bolt: 60mm

31001



- Garden gate lock, RAL 6005
- For square profiles Ø 40mm
- Stainless steel mechanism with Polyamide housing

31002

- Garden gate lock, RAL 6005
- For square profiles Ø 40mm
- Stainless steel mechanism with Polyamide housing

31003



- Keep to suit 31001 lock, RAL 6005
- For square profiles Ø 40mm
- Polyamide housing

31004



- Keep to suit 31002 lock, RAL 6005
- For Round profiles Ø 40mm
- Polyamide housing

31005



- Industrial lock
- For square profiles Ø 30 to 50mm
- Stainless steel mechanism with aluminium housing

31006

- Industrial lock
- For flat profiles 10 to 30mm
- Stainless steel mechanism with aluminium housing

31007



- Keep to suit 31005/31006 lock, RAL aluminium
- Adjustable for profiles Ø 40 to 60mm

31008



- Keep to suit 31005/31006 lock, RAL aluminium
- Adjustable for profiles Ø 40 to 60mm
- Extra security











31009



- Lever handle, pair
- Black Polyamide

SLIDING GEAR STRONG CANTILEVER GATE SYSTEM

- Suitable for steel and timber, manual or automated gates
- Up to 9m wide gate
- Low maintenance system
- Quick to install

System includes		System includes 1 top guide out of the 6 types below:	
	1 x Running Track		51213 (3m gate) (1x)
	2 x Bottom Rollers		51214 (4.5m gate) (1x)
	2 x Fixing Bolt Sets (4pcs)		51215 (52mm dia) (2x)
	2 x End Guides		51216 (40mm dia) (2x)
	2 x End Guide Receivers		51217 (60mm dia) (2x)
Select from 6 options	1 x Top Guide		51218 (40mm dia) (2x)

Model Ref:	Maximum Opening Width (m)	Track (3m or 6m)	Bottom Rollers (2 sets)	Fixing Bolts (2 sets)	End Guide (2 x)	End Guide Receiver/ Stop (2 x)	Top Guide Galvanised (1 x)
STR900	4.5m	51219 (3m Black) 51220 (3m Galv) 51221 (6m Black) 51222 (6m Galv)	51201	51204	51207	51210	6 options
STR1000	6m	51223 (3m Black) 51224 (3m Galv) 51225 (6m Black) 51226 (6m Galv)	51202 +51219 Cover Plate	51205	51208	51211	6 options
STR2000	9m	51227 (3m Black) 51228 (3m Galv) 51229 (6m Black) 51230 (6m Galv)	51203 +51219 Cover Plate	51205	51209	51212	6 options

MORE THAN STEEL

SLIDING GEAR

STRONG CANTILEVER GATE SYSTEM

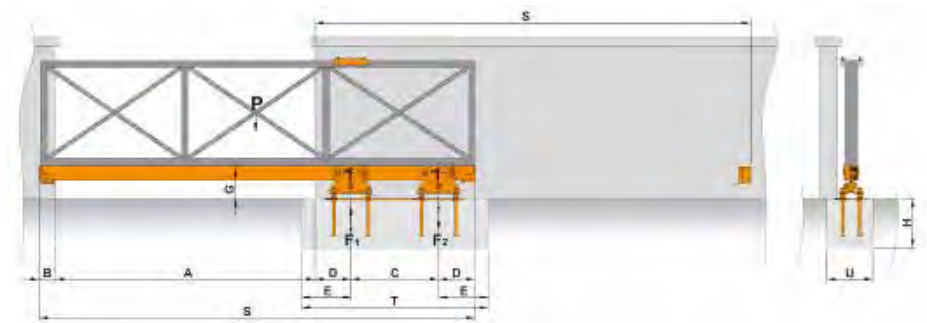

Key

P max (kg): Total weight of the gate and track
 A (m): Overall opening
 S (m): Total length of gate
 C (m): Distance between centres of rollers
 F1 max (kg): Maximum acting load for optimal roller performance

F2 (kg): Traction force
 B (m): Space required for receivers
 D (m): Space required for housing the end wheel
 Z min (kg): Minimum weight of concrete base
 TxUxH min (m): Minimum dimension of the cement base

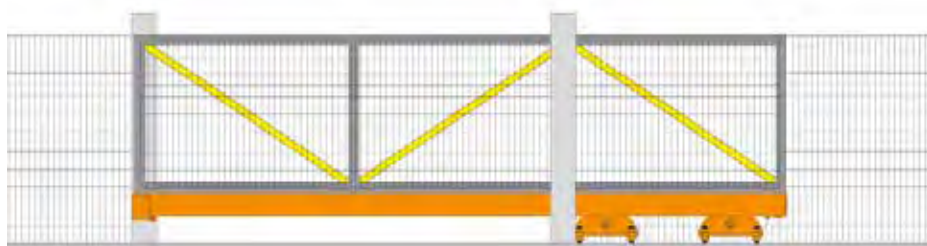

Gate with continuous overhang

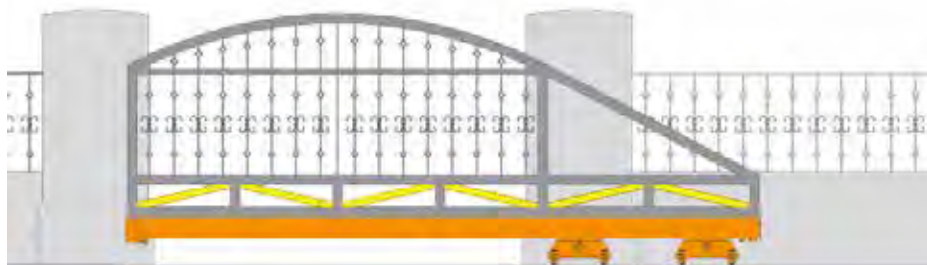

Gate with angle braced overhang

SLIDING GEAR STRONG CANTILEVER GATE SYSTEM

Dimensions				Gate with continuous overhang			Gate with angle braced overhang		
A (m)	C (m)	S (m)	TxUxH min (m)	Pmax [kg]	Zmin [kg]	Pmax [kg]	Pmax [kg]	Zmin [kg]	
1,5	0,60	2,6	1,10x0,40x0,40	255	510	without track	190	675	168
2	0,80	3,3	1,30x0,40x0,40			233			162
2,5	1,00	4,0	1,50x0,40x0,40			223			158
3	1,20	4,7	1,70x0,40x0,40			216			151
3,5	1,40	5,4	1,90x0,40x0,40			212			147
4	1,60	6,1	2,10x0,40x0,40			208			141
4,5	1,80	6,8	2,30x0,40x0,40			202			137
Fixed data: F1max (kg) 450 D (m) 0,195 B (m) 0,110 Gmin (m) 0,05 Emin (m) 0,25									

STR 900 Series

Dimensions				Gate with continuous overhang			Gate with angle braced overhang		
A (m)	C (m)	S (m)	TxUxH min (m)	Pmax [kg]	Zmin [kg]	Pmax [kg]	Pmax [kg]	Zmin [kg]	
3	1,20	4,8	1,90x0,60x0,60	565	1110	without track	425	1490	389
3,5	1,40	5,5	2,10x0,60x0,60			509			363
4	1,60	6,2	2,30x0,60x0,60			503			355
4,5	1,80	6,9	2,50x0,60x0,60			495			349
5	2,00	7,6	2,70x0,60x0,60			489			340
5,5	2,20	8,3	2,90x0,60x0,60			480			334
6	2,40	9,0	3,10x0,60x0,60			474			325
Fixed data: F1max (kg) 1000 D (m) 0,260 B (m) 0,115 Gmin (m) 0,08 Emin (m) 0,35									

STR 1000 Series

Dimensions				Gate with continuous overhang			Gate with angle braced overhang		
A (m)	C (m)	S (m)	TxUxH min (m)	Pmax [kg]	Zmin [kg]	Pmax [kg]	Pmax [kg]	Zmin [kg]	
3	1,20	4,9	2,10x0,80x0,80	850	1665	without track	645	2210	551
4	1,60	6,3	2,50x0,80x0,80			756			526
5	2,00	7,7	2,90x0,80x0,80			731			501
6	2,40	9,1	3,30x0,80x0,80			708			476
7	2,80	10,5	3,70x0,80x0,80			681			451
8	3,20	11,9	4,10x0,80x0,80			656			426
9	3,60	13,3	4,50x0,80x0,80			631			401
Fixed data: F1max (kg) 1500 D (m) 0,290 B (m) 0,115 Gmin (m) 0,08 Emin (m) 0,45									

STR 2000 Series

**HUGE STOCK
RANGE
AVAILABLE
FOR
IMMEDIATE
DELIVERY.**

**NEW!
PRODUCT
LINE.**



SQUARE ERW

DIMENSION	THICKNESS		
	1.5	2	3
	6000	6000	6000
12 x 12	•		
14 x 14	•		
16 x 16	•		
20 x 20	•		
25 x 25	•	•	
30 x 30	•	•	
40 x 40	•	•	•
50 x 50	•	•	
60 x 60	•		

ROUND

DIMENSION	THICKNESS		
	1.5	2	3
	6000	6000	6000
12	•		
14	•		
16		•	
18	•	•	
19	•		
20	•	•	
22	•		
25	•		
28		•	
30	•	•	
35	•		
38	•		
40		•	
50	•	•	
60	•	•	
76		•	
80	•	•	
101,60	•		

RECTANGULAR

DIMENSION	THICKNESS		
	1.5	2	3
	6000	6000	6000
25 x 10	•		
30 x 15	•		
35 x 20	•		
35 x 25	•	•	
40 x 10	•		
40 x 20	•		
40 x 25	•		
40 x 35	•		
50 x 10	•		
50 x 20	•		
50 x 25	•	•	
50 x 30	•	•	
60 x 10	•		
60 x 20	•	•	
60 x 40	•	•	
70 x 40		•	
80 x 20	•	•	
80 x 40	•	•	
80 x 50		•	
100 x 20		•	
100 x 30		•	
100 x 50		•	
120 x 60		•	

**FOR A FAST,
COMPETITIVE QUOTE
CALL NOW!**

ANCILLARY PRODUCTS

SECTION GUIDE

LADDERS.....	149
PLASTIC TUBE INSERTS	151
PALLET FEET	152
PAINT	152
CORNER EDGE PROTECTION	153



Product Selection Guide

To help you make the right selection we have devised a classification system to guide you through the products.



FREQUENT TRADE USE

These products are for trade use and are manufactured to take more wear and tear. They are designed for frequent use.



BRITISH MADE

Products made in Britain.



EXTREME TRADE - FREQUENT USE

Products designed to be used in a more demanding and extreme environment. These are made for frequent use.

Suitable environments



OFFICIAL STOCKISTS

LYTE

Lyte Ladders and Towers have been manufacturing high quality access products in South Wales for over 70 years. Since its inception in 1947 Lyte has been recognised as one of the leading manufacturers in the trade and industrial sector with a reputation for innovative and quality products.

- Products are manufactured at the Lyte Ladders and Towers Ltd premises in the UK.

- All products are kitemarked and certified by the British Standards Institute, where applicable to ensure you are getting the best products possible.

INDUSTRIAL ALUMINIUM SWINGBACK STEPLADDERS



This range of ladders is ideal for trade use and is tested to a durability test of 50,000 cycles.

- Tested & certified to New EN131-2, Professional
- Improved stiles and strengthened treads as well as reinforced platform in line with the new standard requirements
- Unique strengthening beam incorporated into non-slip treads, rubber feet, and twists as there are no tapes to snap, or flimsy arms to break
- Rigid box section back legs with additional cross braces and 'k' straps for increased strength and stability
- Lightweight and easy to carry
- Lower bottom tread to avoid bending of front feet
- Aluminium top tread
- British Made
- Maximum capacity load of 150kg



Ref.	Open Height (M)	Open Depth (M)	Open Width (M)	Closed Height (M)	Closed Width (M)	Closed Depth (M)	Treads	Weight (Kg)
NESS6	1.2	0.95	0.46	1.39	0.46	1.35	6	6.00
NESS8	1.68	1.31	0.5	1.86	0.5	1.35	8	8.00

MORE THAN STEEL

EN131 PLATFORM STEPLADDERS



Strong, lightweight aluminium platform ladder range.

- Certified to the new EN131-2 standard
- Slim design – ideal for storage and transport
- Rubberised feet provide slip resistance and floor protection
- Fitted with high tensile straps



Ref.	Treads	Closed Height (mm)	Open Height (mm)	Platform Height (mm)	Working Height (mm)	Foot-print (mm)	Width (mm)	Weight (Kg)
NENPL6	6	1943	1837	1210	3210	1075	479	6.00

TRADE GLASSFIBRE SWINGBACK STEPLADDERS



American style glassfibre swingback stepladder certified to EN131-2.

- Non conductive to 30,000 volts and so the ladder is ideal for use where electrical hazards exist
- Exceptional integral tool tray for equipment when in use.
- All treads are double riveted to provide extra strength for the user

Ref.	Open Height (M)	Closed Height (M)	Treads	Weight (Kg)
NGFHS4	1.08	1.22	4	5.41
NGFHS6	1.65	1.75	6	7.77



TRADE 2 SECTION LADDERS



Made in the UK and built from the best quality aluminium and certified to EN13-2 Professional for frequent and heavy duty work. Comes with a high quality stabiliser 800mm bar for maximum safety and stability.



Ref.	Open Height (M)	Closed Height (M)	Weight (Kg)
NELT230	4.88	2.92	12.00

- Tested & certified to New EN131-2, Professional
- Manufactured with D shaped rung for comfort when climbing
- Newly designed stabiliser bar which is easy to fit and reduces the risk of sideways slips and gives a larger and safer footprint
- British Made
- Maximum capacity load of 150kg

PLASTIC TUBE INSERTS

- Standard material: LD Polyethylene
- Standard stock colour black — many others available either from stock or on short lead times
- RAL colour matching available on most items
- Popular sizes have “ribbed shank” to suit a range of tube gauges

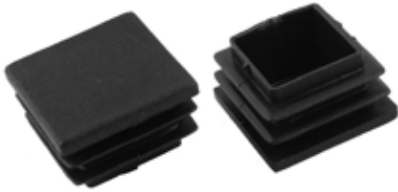

Tube Size mm	Gauge Range	Reference Number (Black)
12 x 12	3.0 - 4.9	9213B
25 x 25	1.0 - 2.0	9201B
25 x 25	2.0 - 3.2	9202B
30 x 30	1.0 - 2.0	9203B
30 x 30	2.0 - 3.0	9204B
32 x 32	1.0 - 2.0	9215B
35 x 35	2.0 - 3.2	9205B
38 x 38	1.0 - 2.0	9216B
40 x 40	1.0 - 2.0	9206B
40 x 40	2.0 - 3.2	9207B
50 x 50	1.2 - 2.0	9208B
50 x 50	2.0 - 3.2	9209B
60 x 60	2.0 - 3.2	920901B
80 x 80	3.0 - 4.9	9224B
80 x 80	3.0 - 4.9	9213B
90 x 90	3.6 - 6.3	9210B
100 x 100	2.0 - 5.0	9211B
150 x 150	3.6 - 6.3	9212B

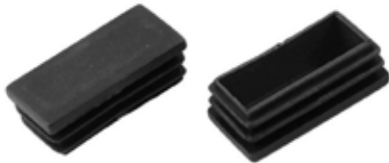

Tube Size mm	Gauge Range	Reference Number (Black)
30 x 20	1.0 - 2.0	9221B
40 x 20	1.2 - 2.0	9222B
50 x 30	1.5 - 3.2	9223B
80 x 40	3.0 - 4.0	9224B



Tube Size mm	Gauge Range	Reference Number (Black)
12	1.0 - 2.0	9231B
12	1.6 - 1.2	9238B
18	1.0 - 2.0	9232B
20	1.0 - 2.0	9233B
25	1.0 - 2.0	9235B
30	1.0 - 2.0	9234B
32	1.0 - 2.0	9236B
38	1.0 - 2.0	9237B

MORE THAN STEEL

PALLET FEET

- Self-Colour
- Ready for welding
- Size Key - H = Height / TW = Top Width or Dia / BW = Bottom Width or Dia (mm)



9301 (54H x 54TW x 127BW)
Thickness: 2.4
Weight (Kg/100): 50
Max post size: 60
Max Load: 2T per FO



9302 (54H x 54TW x 127BW)
Thickness: 3.0
Weight (Kg/100): 60
Max post size: 60
Max Load: 3T per FO



9304 (64H x 60TW x 130BW)
Thickness: 6.4
Weight (Kg/100): 144
Max post size: 70



9305 (52H x 80TW x 152BW)
Thickness: 4.8
Weight (Kg/100): 125
Max post size: 80



9308 (52H x 127BW)
Thickness: 3.0
Weight (Kg/100): 49
Max post size: 70



9309 (38H x 48TW x 127BW)
Thickness: 3.0
Weight (Kg/100): 31
Max post size: 60



9310 (26H x 27TW x 64BW)
Thickness: 1.6
Weight (Kg/100): 6.3
Max post size: 25



9312 (21H x 40TW x 66BW)
Thickness: 1.6
Weight (Kg/100): 6.3
Max post size: 45



9313 (54H x 130BW)
Thickness: 3.0
Weight (Kg/100): 39.5
Max post size: 70

PAINT HIGH BUILD ZINC PHOSPHATE PRIMER

- Pre welded primer
- High build zinc phosphate - hard wearing
- Suitable for application by spray, brush or roller
- Good coverage - very economical
- 2.5 Litre tins : Red (Ref: 914.5) | Black (Ref: 916.5) | Grey (Ref: 915.5)
- 5.0 Litre tins : Red (Ref: 911.5) | Black (Ref: 912.5) | Grey (Ref: 913.5)

Please refer to data-sheet for surface preparation and application.

CORNER+EDGE PROTECTION

TPE FOAM PROTECTION



B+M TPE (Thermoplastic elastomer) EDGING PROTECTION STRIP comes in a selection of sizes and colours to suit your requirements.

Available for PU SEALANT/NEOPRENE GLUED or SELF-ADHESIVE, our TPE edging strips have a variety of uses, cushioning accidental impacts.

ROUND FOAM PROTECTOR

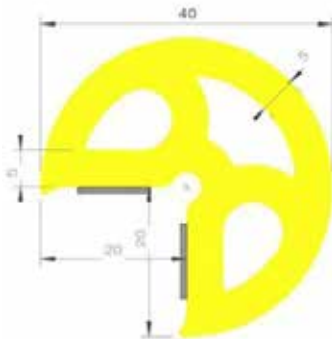

SPECIFICATIONS

	SELF-ADHESIVE	GLUED
Yellow 1018	PM29007	PM29015
Grey 7040	PM29011	PM29014
Black	PM29012	PM29013



MORE THAN STEEL

EDGE FOAM PROTECTOR



'U' FOAM PROTECTOR

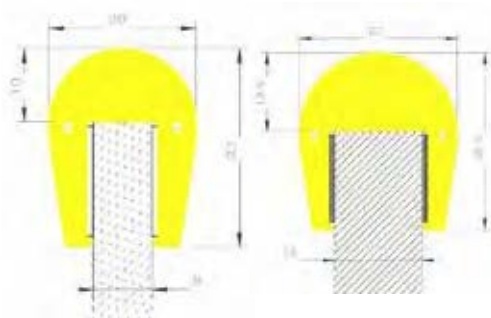

8mm PROTECTOR

15mm PROTECTOR

SPECIFICATIONS

	SELF-ADHESIVE	GLUED
Yellow 1018	PM29008	PM29018
Grey 7040	PM29016	PM29019
Black	PM29017	PM29020

8mm SPECIFICATIONS

	SELF-ADHESIVE	GLUED
Yellow 1018	PM29009	PM29023
Grey 7040	PM29021	PM29024
Black	PM29022	PM29025

15mm SPECIFICATIONS

Yellow 1018	PM29010	PM29028
Grey 7040	PM29026	PM29029
Black	PM29027	PM29030

ELASTOMER PROTECTION RANGE

FOR A FAST, COMPETITIVE QUOTE
CALL NOW!

ALSO AVAILABLE
IN OUR ANCILLARY
PRODUCT RANGE IS THE
ELASTOMER RANGE OF EDGE
PROTECTION.





**NO
MINIMUM
QUANTITY**

HI-DEF PLASMA PROFILING

**CUTTING, SLOTTING, DRILLING &
ETCHING SERVICE FROM DRAWING**

We're always investing in new machinery to increase the products & services we offer.

With a plasma facility for cutting materials up to 50mm thick and drilling holes from 8mm to 40mm diameter, (240mm by milling). Delivered to your door from drawing in 5 working days (subject to stock availability).

Please contact us for further details and specifications.

ABERDEEN

Claverfield Rd, Bridge of Don
 ABERDEEN AB23 8FE
 T: 01224 702 771
 aberdeen@bmsteel.co.uk

AVON

Unit 18 Midsomer Enterprise Park,
 Radstock Road,
 Midsomer Norton
 AVON BA3 2BB
 T: 01761 416721
 avon@bmsteel.co.uk

BANGOR

Unit 18, Llandygai Ind. Est.
 BANGOR LL57 4YH
 T: 01248 364 041
 bangor@bmsteel.co.uk

CHEADLE

Duke Avenue,
 Stanley Green Ind. Est.
 CHEADLE HULME SK8 6QZ
 T: 0161 485 8535
 cheadle@bmsteel.co.uk

GLASGOW

Shieldhall Works, Hardgate Rd,
 GLASGOW G51 4TB
 T: 0141 445 2591
 glasgow@bmsteel.co.uk

LIVERPOOL

Byng St/Seymour St,
 Millers Bridge Ind. Est.
 BOOTLE L20 1EE
 T: 0151 922 4265
 liverpool@bmsteel.co.uk

MORECAMBE

Unit 2, Middlegate,
 White Lund Ind.
 MORECAMBE LA3 3BN
 T: 01524 67241
 morecambe@bmsteel.co.uk

NOTTINGHAM

Basford Works, Arnold Rd,
 NOTTINGHAM NG6 0EF
 T: 0115 970 1171
 nottingham@bmsteel.co.uk

PETERBOROUGH

Oxney Road,
 Eastern Industry,
 PETERBOROUGH PE1 5YW
 T: 01733 312 921
 peterborough@bmsteel.co.uk

PRESTON

Unit 1, Sellers St,
 PRESTON PR1 5EU
 T: 01772 459 111
 preston@bmsteel.co.uk

BARCLAY & MATHIESON

293 Coleford Rd, Darnall
 SHEFFIELD S9 5NF
 T: 0114 254 3220
 sales@barclayandmathieson.com

BM ARCHITECTURAL

293 Coleford Rd, Darnall
 SHEFFIELD S9 5NF
 T: 0114 254 3226
 sales@bmarchitectural.com

IMS SITTINGBOURNE

1-5 Millen Rd, Sittingbourne,
 KENT ME10 2BQ
 T: 01795 293 104
 sales@industrialmetal.co.uk

IMS SHOEBURNESS

Metalstock House,
 Vanguard Way
 ESSEX SS3 9RE
 T: 01702 296 955
 sales@industrialmetal.co.uk

PULMAN STEEL

Walton Street, Sowerby Bridge
 WEST YORKSHIRE HX6 1AN
 T: 01422 833 993
 sales@puls.co.uk

SPS STEEL PLATE & SECTIONS

Shieldhall Works, Hardgate Rd,
 GLASGOW G51 4TB
 T: 0141 440 5860
 sales@sps-bmsteel.co.uk

ANGUS F GUNN

Dalmacoulter Road,
 Stirling Road Industrial Estate,
 AIRDRIE ML6 7UD
 T: 01236 766 102
 sales@angusgunn.co.uk